

2021+ FORD F150 XB LED GRILLE INSTALL GUIDE

WARNING: By reading this document, you agree it is only to be used as an educational guide. Morimoto Lighting nor its dealers make guarantees on any finished results, nor are they to be held responsible for any damage, misuse, or personal injuries. If you are unable to clearly understand and adapt the information below, professional installation is recommended.

PACKAGE CONTENTS

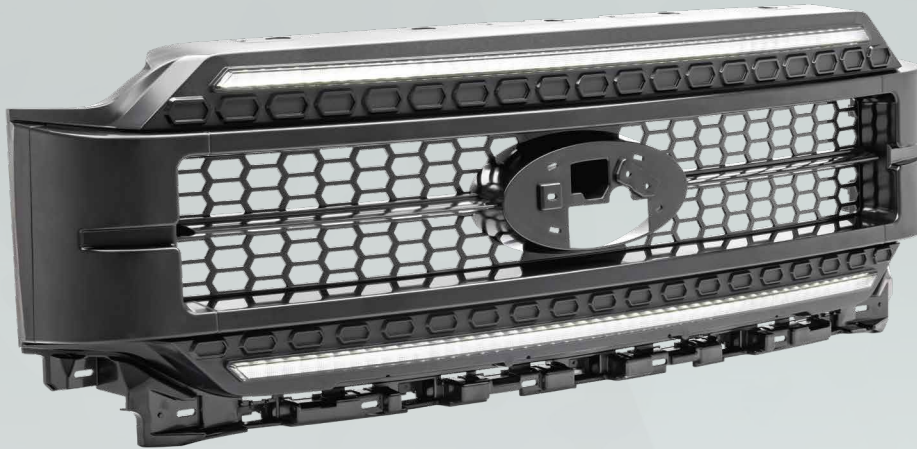

1 X XBG GRILLE



1 X FUSE TAP / DRL HARNESS



1 X HALOGEN ADAPTER HARNESS



1 X OEM LED ADAPTER HARNESS

2021+ FORD F150



TABLE OF CONTENTS

- INSTALLATION PROCESS	PAGE 3
- FRONT TRIM REMOVAL INSTRUCTIONS	PAGE 14
- DISABLE DRL IN FOG LIGHT	PAGE 15
(FOR LED TRUCKS)	

REQUIRED TOOLS

- RATCHET
- 7MM SOCKET
- 8MM SOCKET
- 10MM SOCKET
- FLAT HEAD SCREWDRIVER OR TRIM REMOVAL TOOL
- PHILIPS HEAD SCREWDRIVER
- NEEDLE NOSE PLIERS

INSTALLATION PROCESS

1. Remove the fourteen (14) plastic clips holding on the grille cover. Remove the grille cover off of the truck.

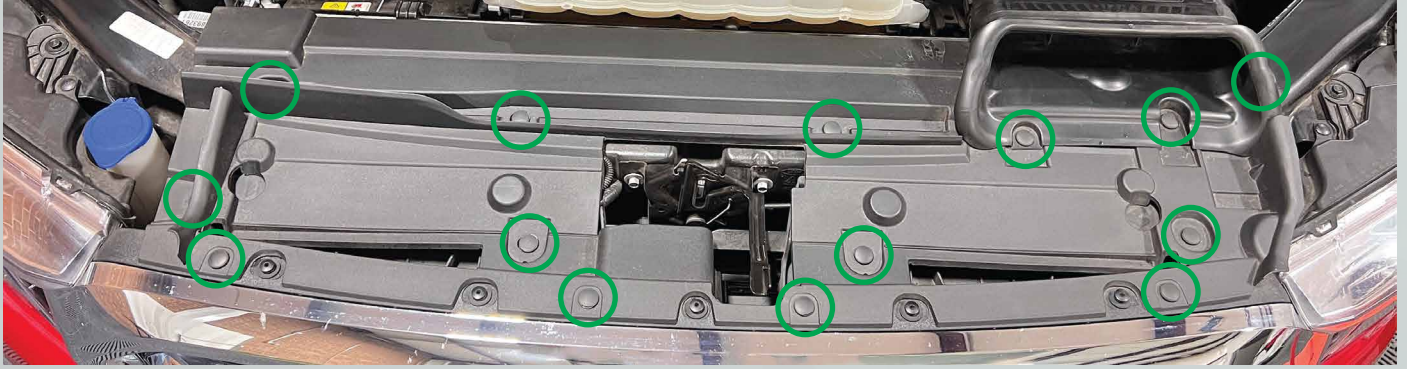

2. Remove four (4) 10mm bolts and two (2) plastic clips holding the top of the grille.



3. At the top of the grille, disconnect the active grille motor (IMAGE 1). Disconnect the camera wire (IMAGE 2), and release the camera washer fitting by pressing the two edges in and sliding the fitting out. Also release the camera washer hose from the holder (IMAGE 3)

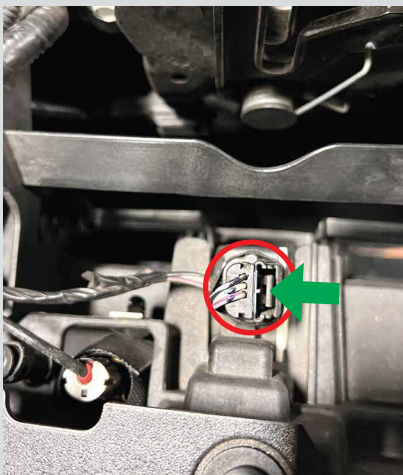

IMAGE 1



IMAGE 2



IMAGE 3

4. Remove the two (2) 7mm screws holding the bumper trim (IMAGE 4). Pry out the bumper trim away from the fender (IMAGE 5). Repeat this on the other side of the vehicle.



IMAGE 4



IMAGE 5

5. Release the bumper trim from the grille by pulling it forward away from the truck. Remove the bumper trim off of the truck.



6. Remove the two (2) 8mm screws (one on each side) holding the bottom of the grille (IMAGE 6). Pull the grille forward away from the truck (IMAGE 7). Remove the grille off of the truck.

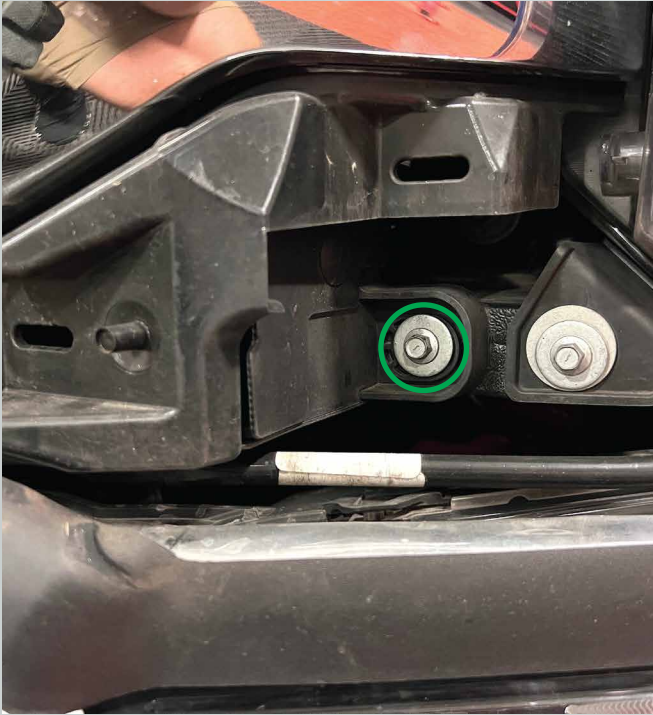

IMAGE 6

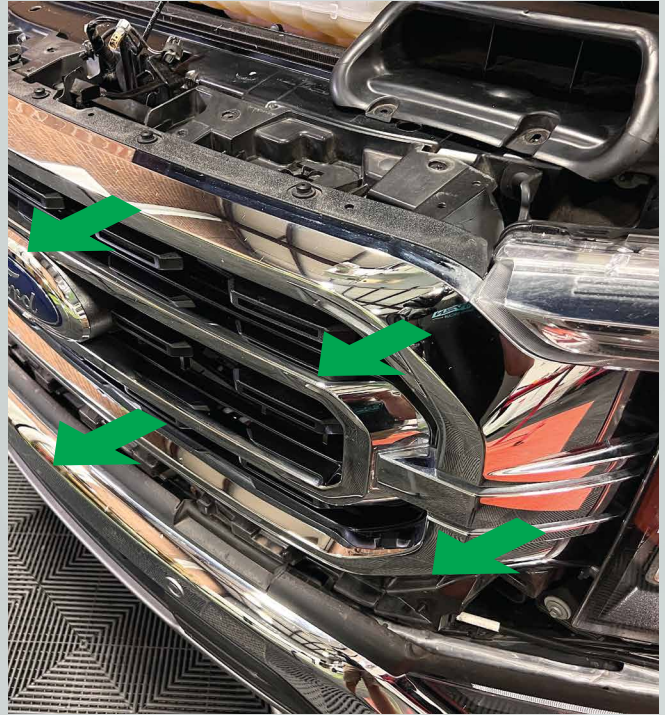

IMAGE 7

7. Remove the one (1) 8mm screw and one (1) 10mm nut holding the bottom of the passenger headlight (IMAGE 8). Remove two (2) 10mm screws and one (1) plastic clip holding the top on the headlight (IMAGE 9).

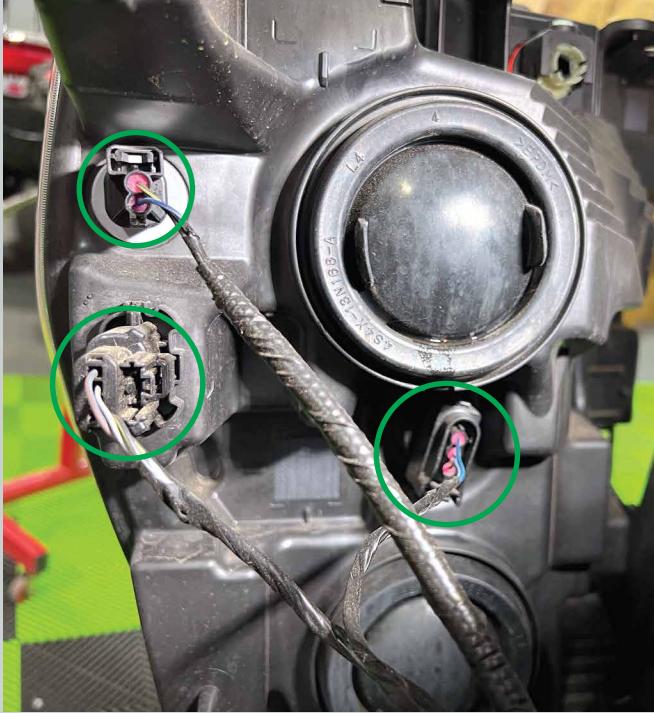

IMAGE 8

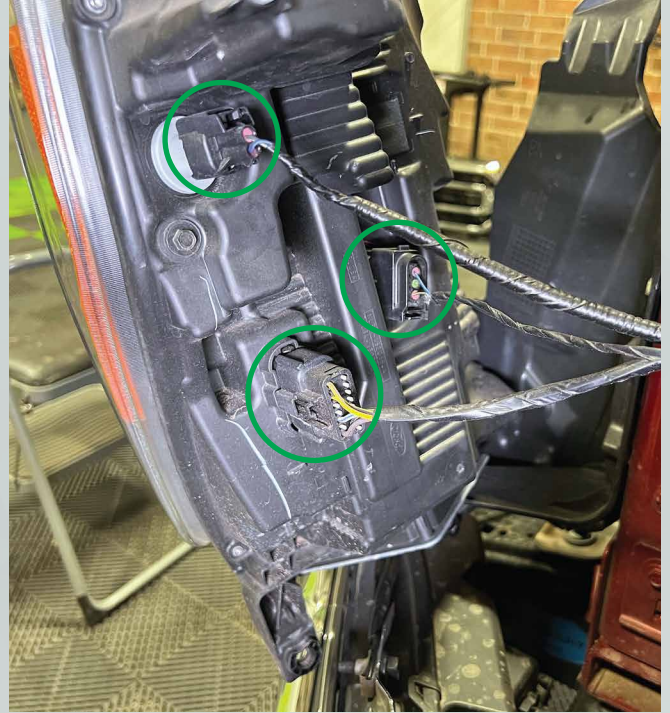

IMAGE 9

8. To remove the headlight, first slide it forward away from the truck, then unplug the three (3) connectors on the back. If you have a halogen truck see IMAGE 10. If you have an OEM LED reflector truck see IMAGE 11.



OEM HALOGEN



OEM LED REFLECTOR

9. Locate the fuse box under the hood on the passenger side, by the firewall and remove fuse #25. Find the included fuse tap harness and plug it in place of the fuse you just removed. Route the end of the harness to the passenger side headlight area. (IF YOU ARE USING MORIMOTO HEADLIGHTS, USE THE FUSE TAP HARNESS THAT IS INCLUDED WITH THE HEADLIGHTS)

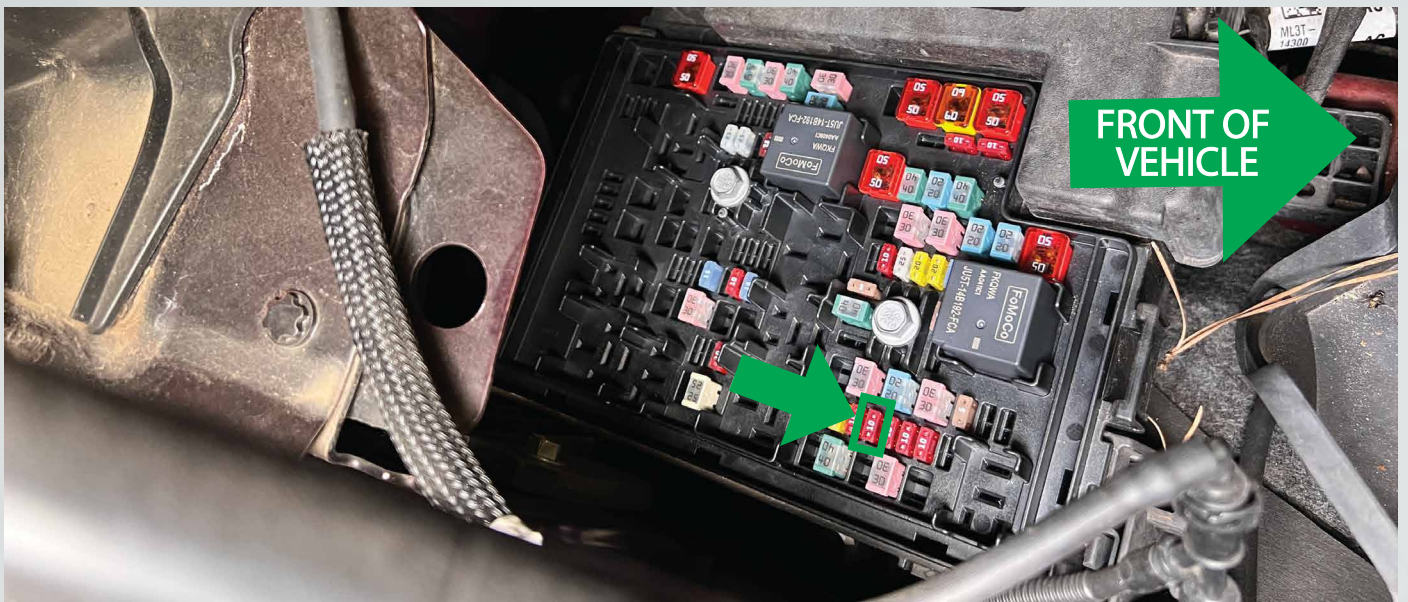

OEM HEADLIGHT IDENTIFIER



OEM HALOGEN



OEM LED REFLECTOR

10. Locate the included adapter harness. Plug it inline between your truck wiring and the headlight wiring. Route the wiring with the two (2) connectors, that go the grille, toward the grille area. Install the headlight.

OEM HALOGEN TRUCK USING MORIMOTO XB HEADLIGHTS



USE HALOGEN ADAPTER HARNESS

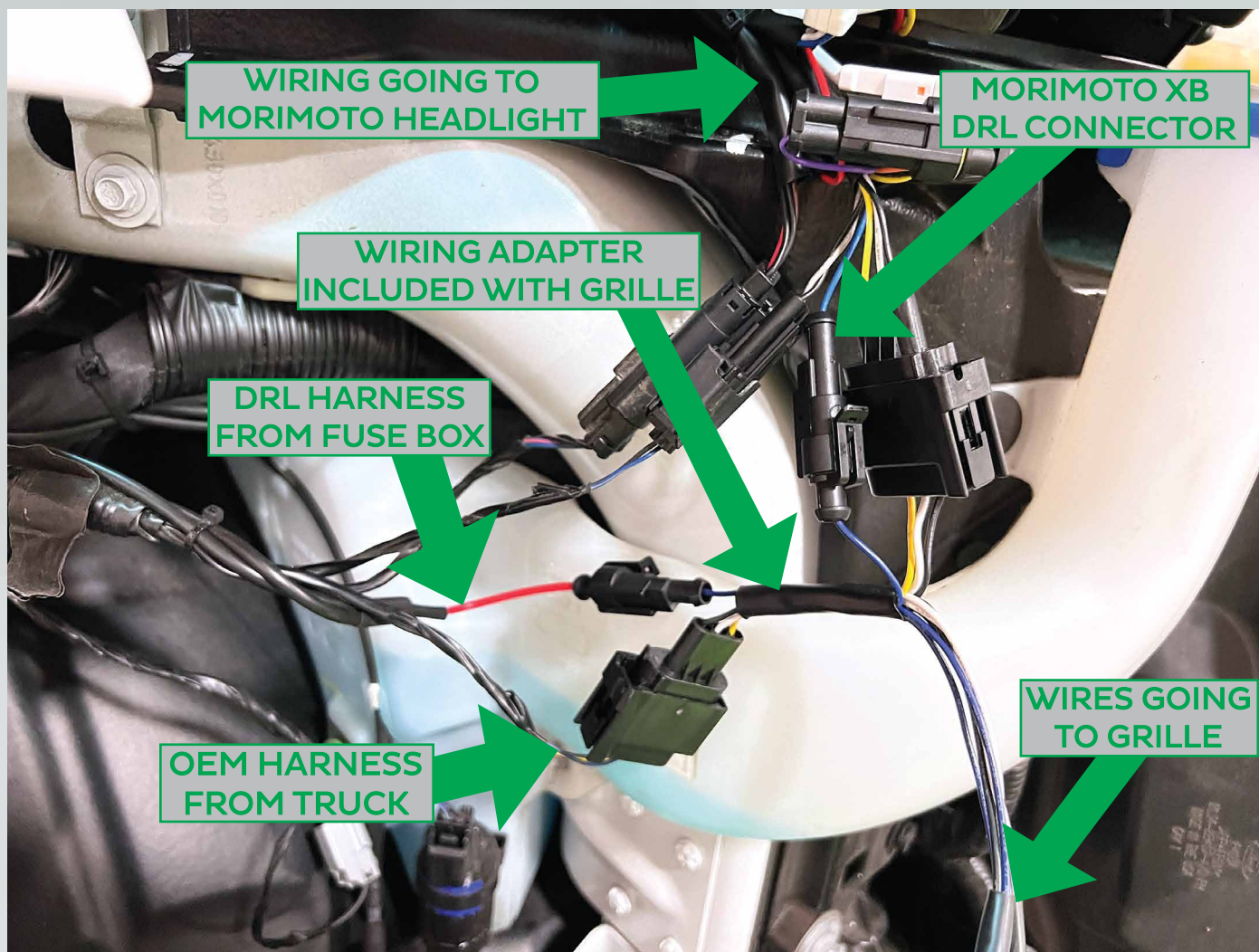

OEM LED REFLECTOR TRUCK USING MORIMOTO XB HEADLIGHTS



USE HALOGEN ADAPTER HARNESS

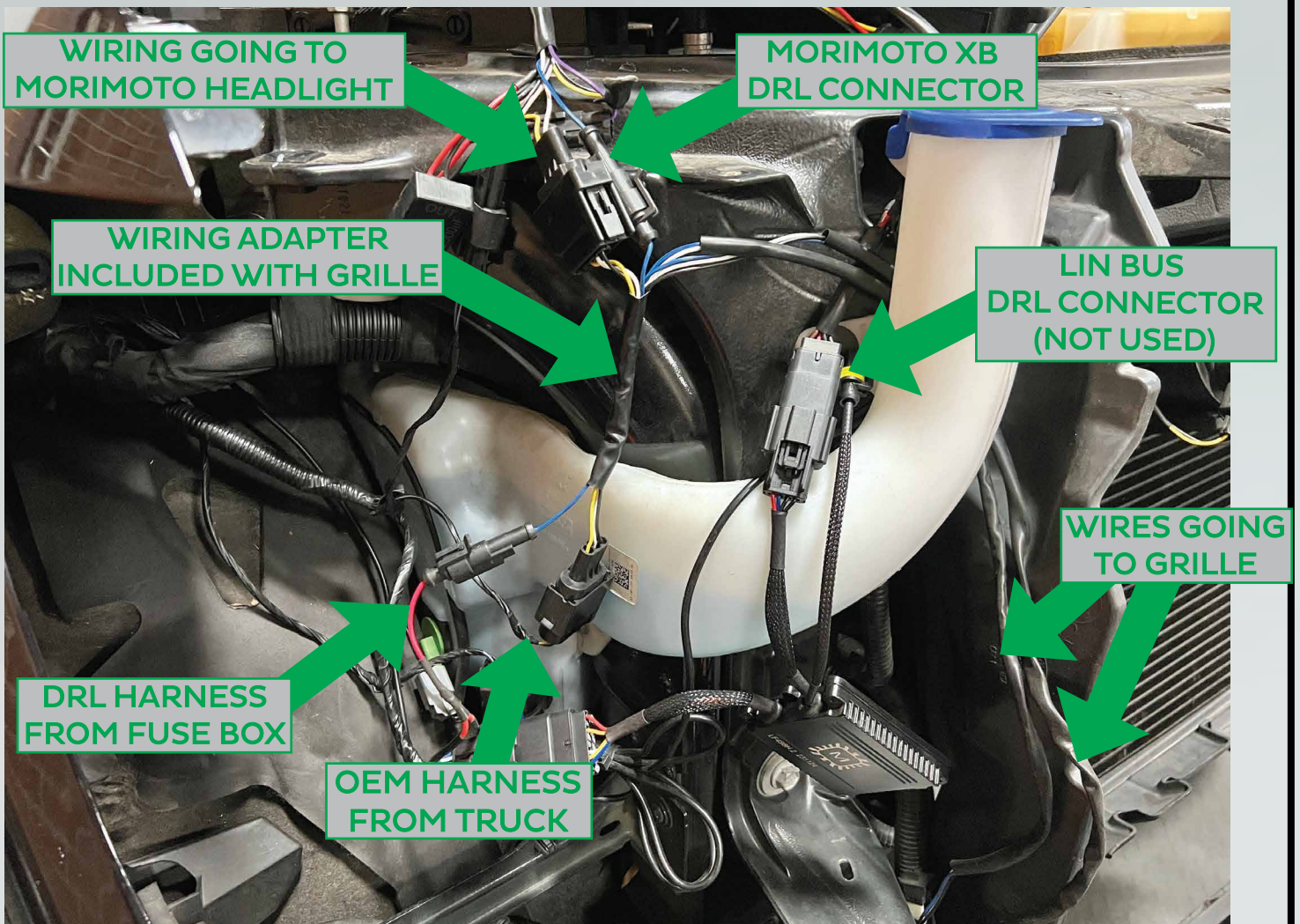

OEM LED TRUCK USING OEM LED HEADLIGHTS



USE OEM LED ADAPTER HARNESS

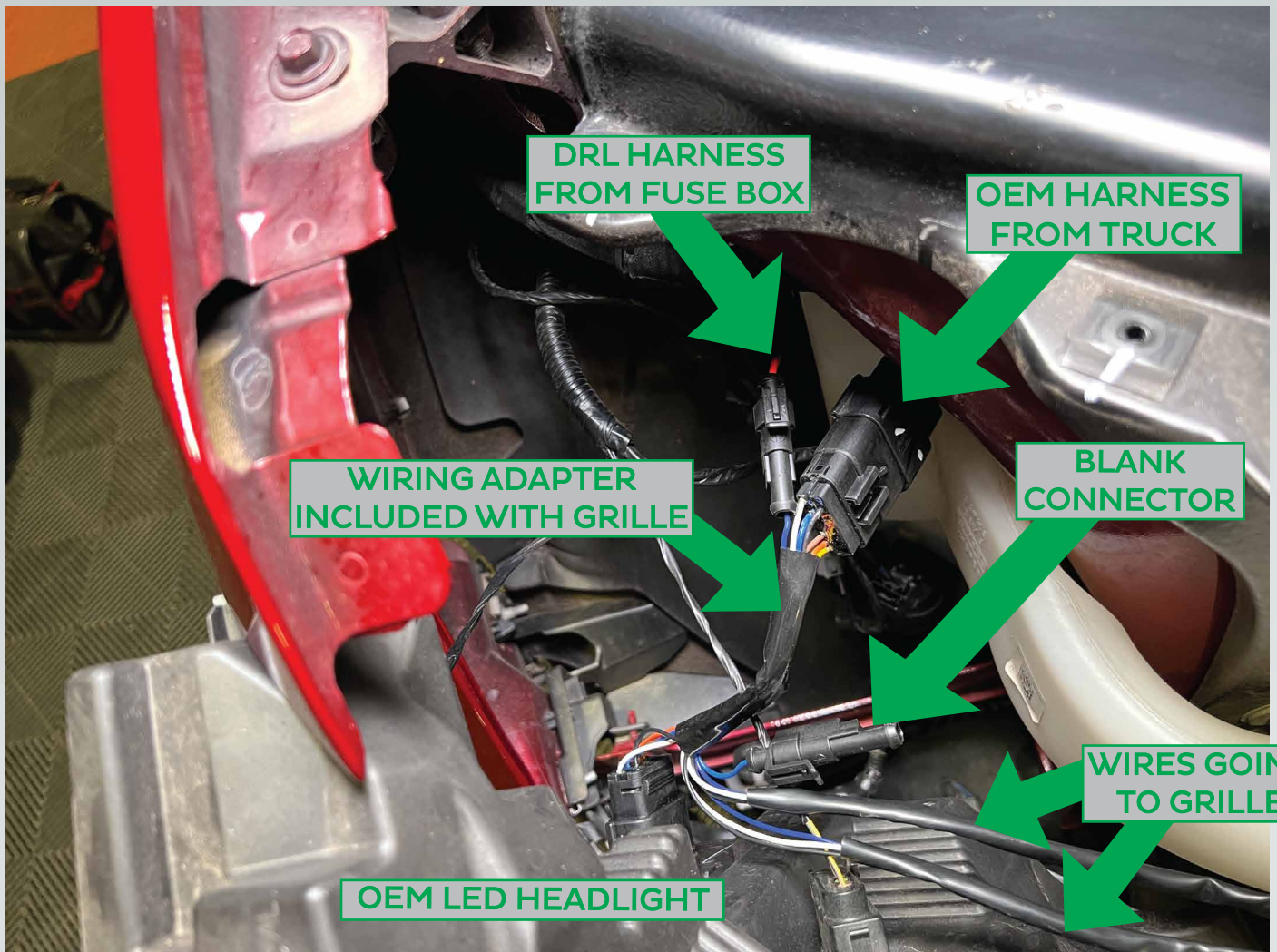

11. To get the active grille swapped over to the Morimoto grille here are the following steps. Get your OEM grille and remove four (4) 10mm nuts circled on the sides and one (1) 8mm screw from the middle of the grille.

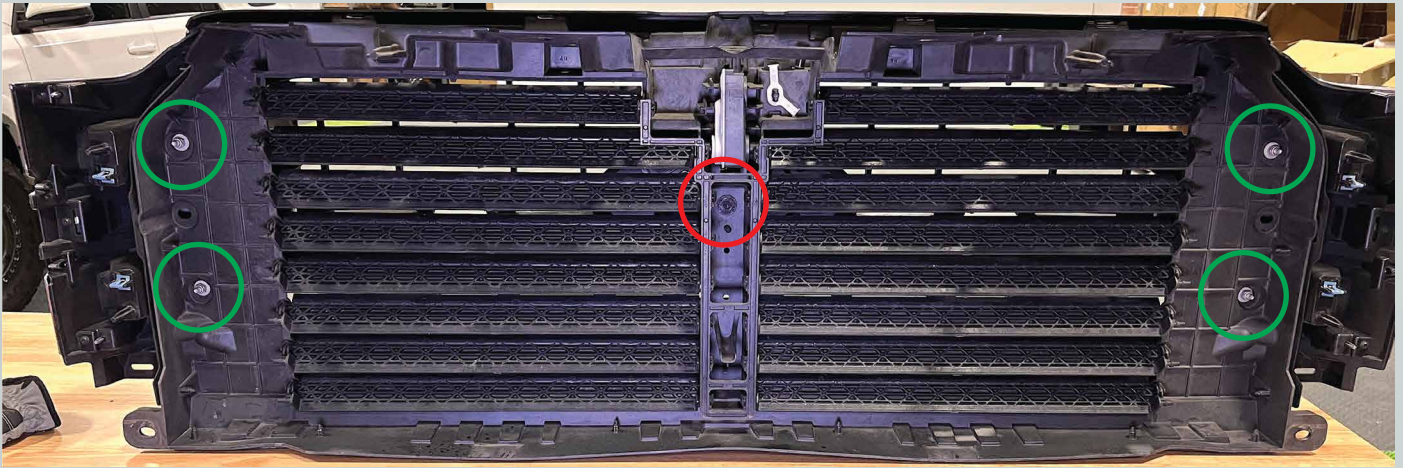

12. On the top of the grille, remove five (5) plastic push clips.



13. On the bottom of the grille, these five (5) clips will need to be released. Do this by pressing up on the lip and the clip should release. While unlocking the clips slowly separate the two halves of the grille.



14. Once the grille is split open, if you have a front camera then go ahead and unplug the washer line (IMAGE 12), and the camera connector (IMAGE 13).

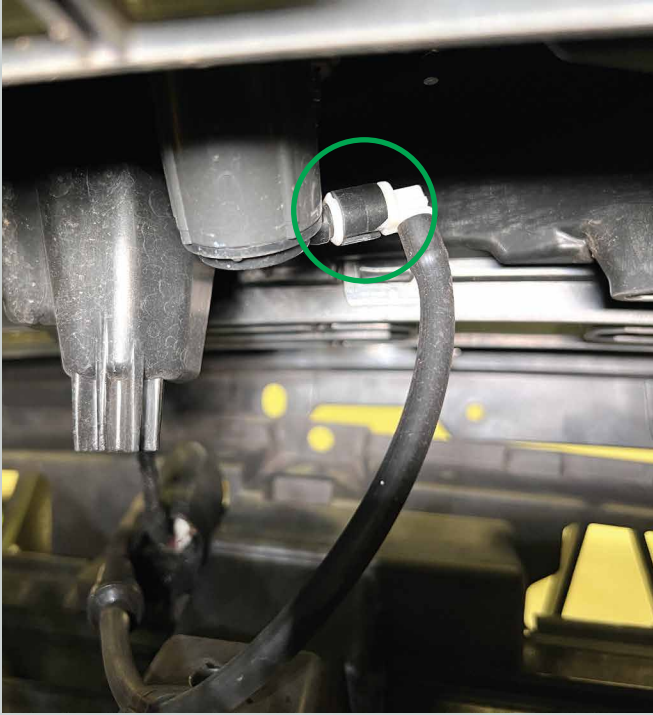
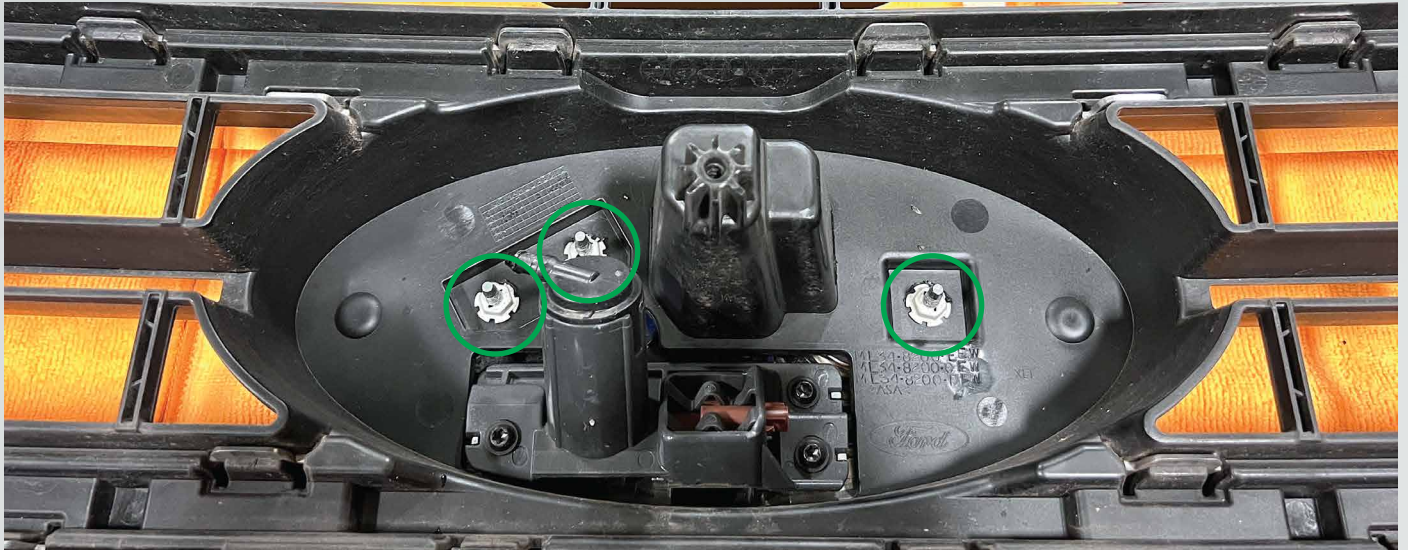

IMAGE 12



IMAGE 13

15. Remove the three (3) 10mm nuts on the back of the FORD emblem and remove the emblem. And install it into your Morimoto grille (HAND TIGHTEN ONLY).



16. Install your Morimoto grille onto the OEM active grille piece. Make sure the XBG wiring doesn't get trapped in between the 2 halves but make sure it comes out of the passenger side.
- If you have the OEM camera and washer connect them before you lock the halves together.
 - Now make sure the bottom metal clips lock in.
 - Reinstall the four (4) 10mm nuts, two on each side of the grille.
 - Reinstall the one (1) 8mm screw on the center of the grille (behind the emblem).
 - Reinstall the five (5) plastic clips on the top of the grille.

17. Set the grille onto the bumper and plug in the two (2) XBG connectors into the connectors that are run from the back of the passenger side headlight (these 2 connectors are interchangeable). Tuck the wiring behind the headlight so it's not in the way of the grille mounting to the truck.

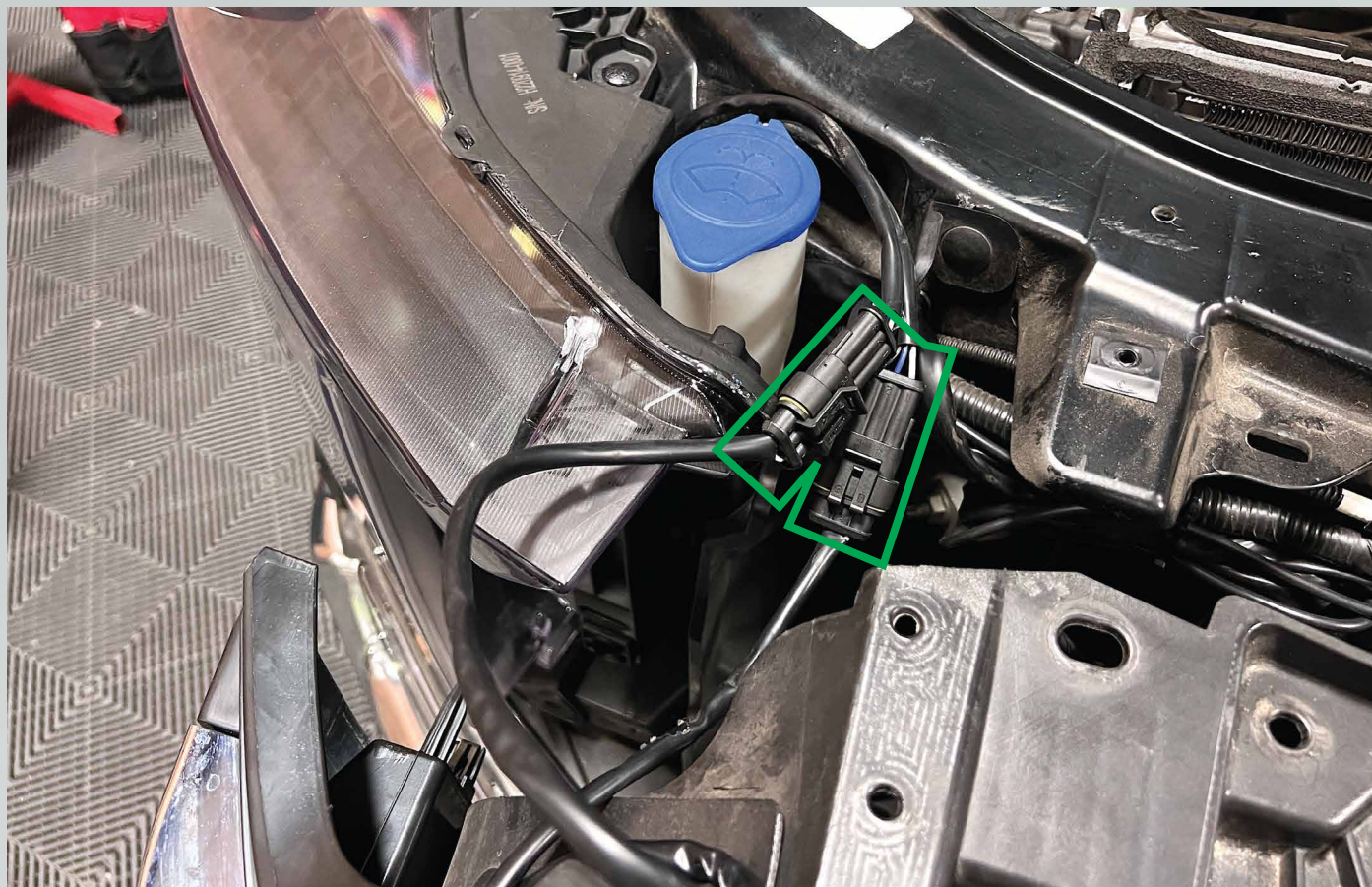

33. Set the grille into it's resting place. Plug in the OEM wiring at the top of the grille.
34. Turn the truck on and test all of the functions.
35. Reassemble the truck in the opposite order of removal.

ENJOY YOUR NEW MORIMOTO XBG GRILLE!

FRONT TRIM SWAP INSTRUCTIONS

(FOR REMOVING THE PAINTABLE TRIM PIECES TO GET PAINTED OR WRAPPED)

1. Remove these eighteen (18) philips head screws to remove the trim piece.



WHEN REINSTALLING THE SCREWS, HAND TIGHTEN ONLY!

DISABLE DRL IN FOG LIGHT

(THIS PROCEDURE IS OPTIONAL)



BEFORE



AFTER

- Remove two (2) 7mm screws and a plastic clip in the fender liner and pull back the fender liner (IMAGE 24). Unplug the fog light (IMAGE 25).



IMAGE 24

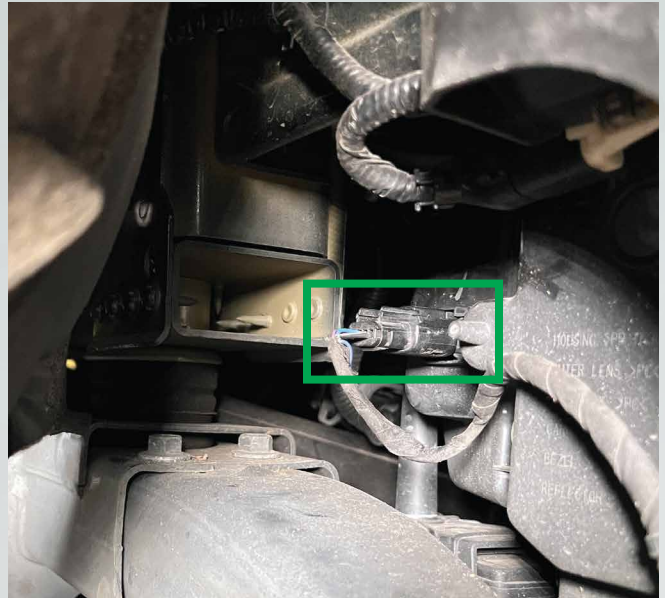

IMAGE 25

- To depin the connector, get a straight pick and remove the white insert by prying it out of the connector via the slot (IMAGE 26).
- Stick the straight pick in the connector and pry the release tab up. While prying the release tab up, pull the wire from the back (IMAGE 27).
- Reinstall the white insert, and wrap the pin you just pulled out with electrical tape (IMAGE 28).



IMAGE 26



IMAGE 27

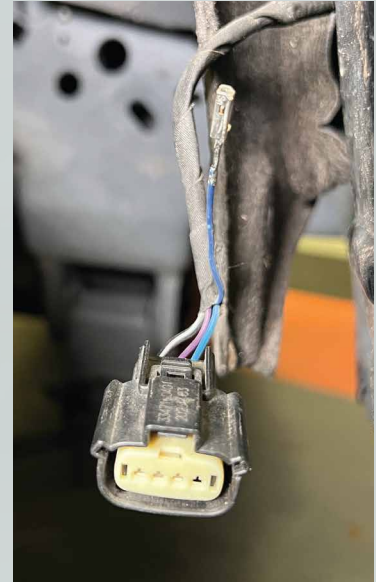

IMAGE 28

- Repeat the previous two steps on the other side of the truck.
- Turn the truck on and go through all of the functions.
- Reassemble the truck in the reverse order that you took it apart.