



THE AUTOMOTIVE LIGHTING BENCHMARK

2020-22 SUPERDUTY XB LED OEM GRILLE INSERTS INSTALL GUIDE

WARNING: By reading this document, you agree it is only to be used as an educational guide. Morimoto Lighting nor its dealers make guarantees on any finished results, nor are they to be held responsible for any damage, misuse, or personal injuries. If you are unable to clearly understand and adapt the information below, professional installation is recommended.

PACKAGE CONTENTS

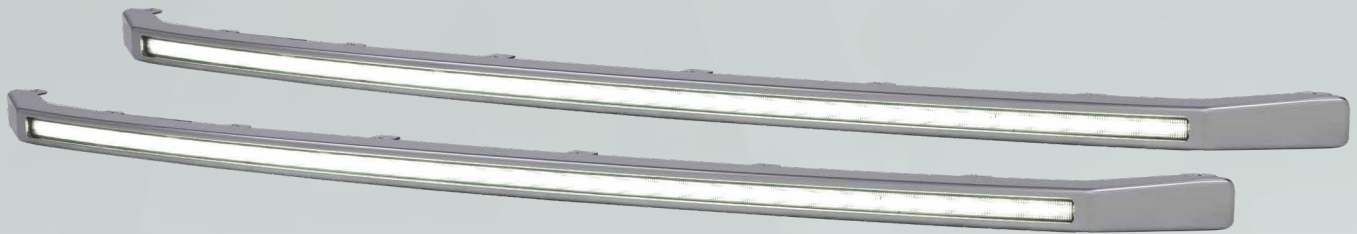

2X TRIM PIECES W/ LED BARS



1 X FUSE TAP / DRL
HARNESS



1 X 15A FUSE



1X OEM LED ADAPTER
HARNESS



1X HALOGEN ADAPTER
HARNESS



1 X LED DRIVER

2020-2022 FORD SUPERDUTY



TABLE OF CONTENTS

- VERTICAL HEADLIGHT AIMING PROCEDURE	PAGE 3
- GRILLE AND HEADLIGHT REMOVAL	PAGE 4
- INSTALL ON A OEM LED TRUCK W/ MORIMOTO HEADLIGHTS	PAGE 9
- INSTALL ON A OEM LED TRUCK W/ OEM LED HEADLIGHTS	PAGE 16
- DISASSEMBLE OEM GRILLE	PAGE 18

REQUIRED TOOLS

- | | |
|---------------|--|
| - RATCHET | - FLAT HEAD SCREWDRIVER OR TRIM REMOVAL TOOL |
| - 10MM SOCKET | - PHILIPS HEAD SCREWDRIVER |
| - 13MM SOCKET | - NEEDLE NOSE PLIERS |
| - PICK TOOL | - TAPE MEASURE |

VERTICAL HEADLIGHT AIMING PROCEDURE

- First park your truck on a level surface 25 feet from a wall.
- Then with a tape measure, measure the distance between the ground and your headlight beam (picture below).
- Write down this measurement.
- Once you install your Morimoto headlights, park the same way as you did with your previous headlights
- Aim your Morimoto headlights to shine as high as your previous headlight (measure ment you too above).
- The general rule is to then drive the truck around and look at surrounding vehicles to make sure your headlight beam isn't directly in their eyes, if it is then lower your headlights. (this may vary depending on how high your truck is from the ground)

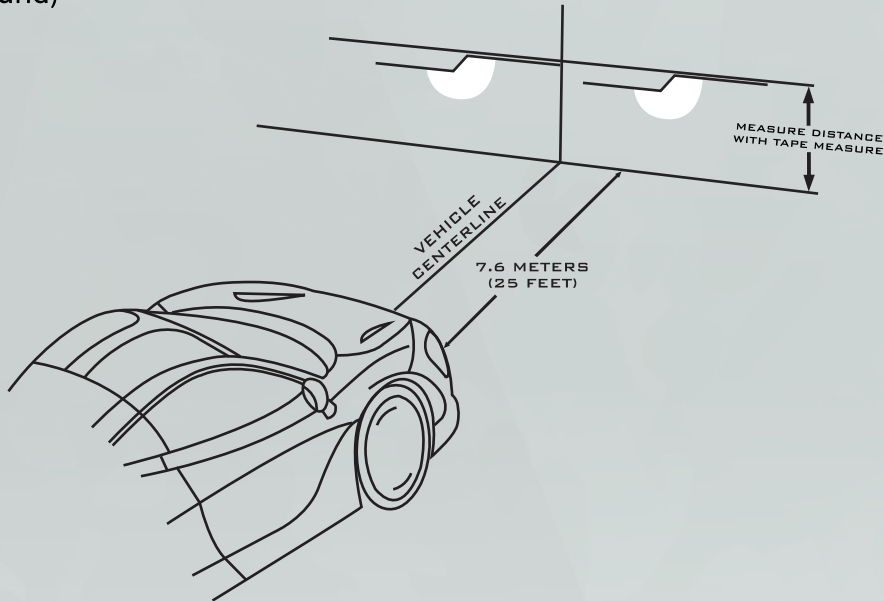

- To adjust the low beam, slide a philips head screwdriver into this slot and turn the screwdriver counter clockwise to move the beam up and turn clockwise to move the beam down.



GRILLE AND HEADLIGHT REMOVAL

1. Remove the fourteen (14) plastic clips holding on the grille cover. Then remove the cover off the truck.

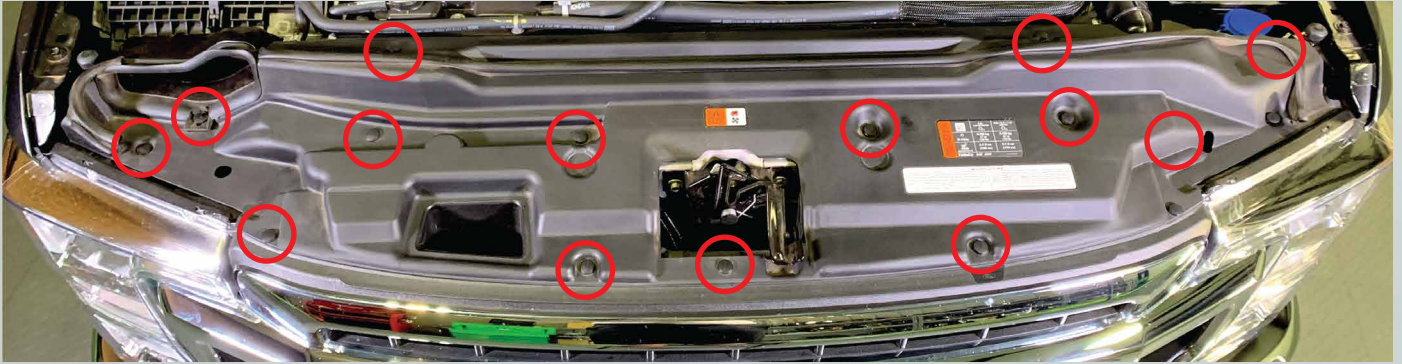

2. Remove the six (6) 10mm bolts holding the top of the grille.

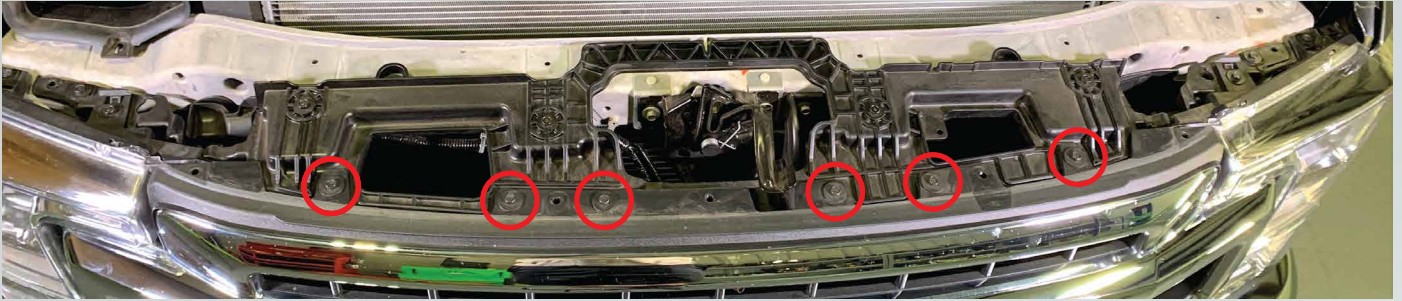

3. Remove one (1) 10mm nut holding the grille to the headlight. Repeat on the other side of the grille.



4. On the bottom of the grille, take a pry tool, and pry this flap towards the middle of the grille. Repeat this on the other side of the grille.



5. Once the flap is off, remove the 10mm bolt. Repeat this on the other side of the grille.



6. Pry the grille forward in these two (2) spots to release the clips. Repeat this on the other side of the grille.

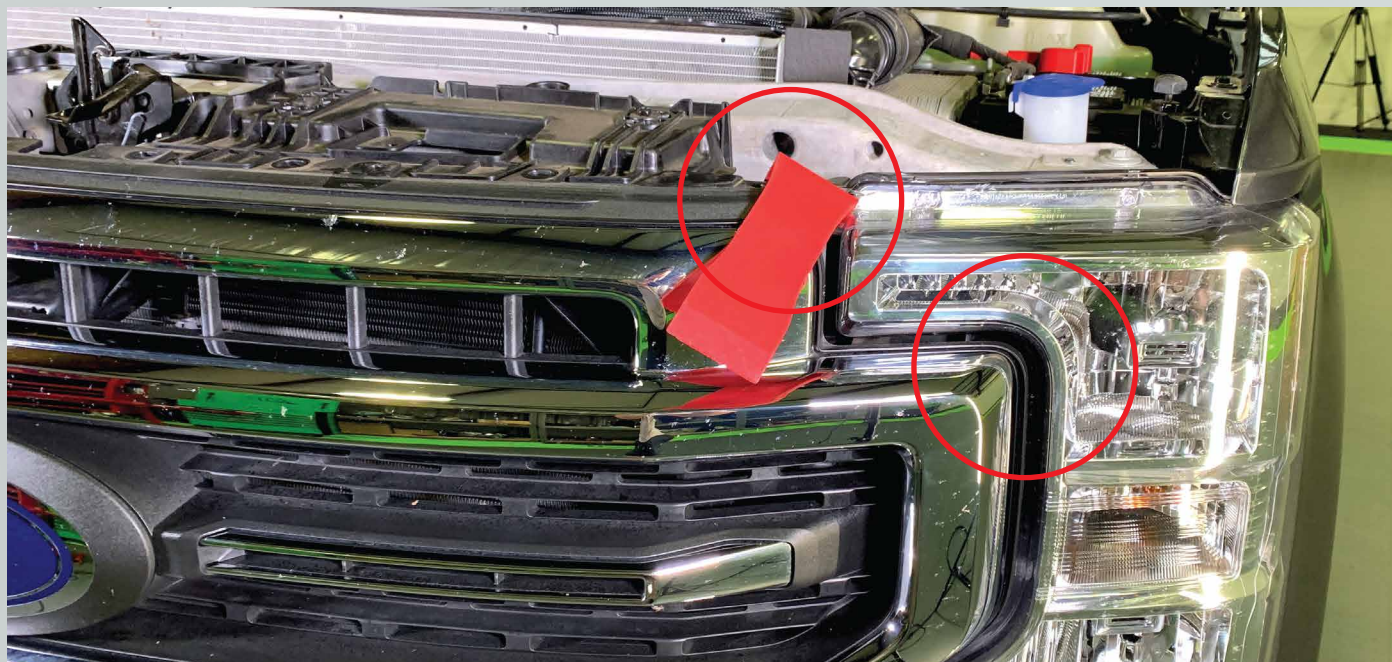

7. With the grille angled forward, take a flat screwdriver and press these four (4) metal clips down to release the bottom of the grille. Now you can remove the grille off of the truck.

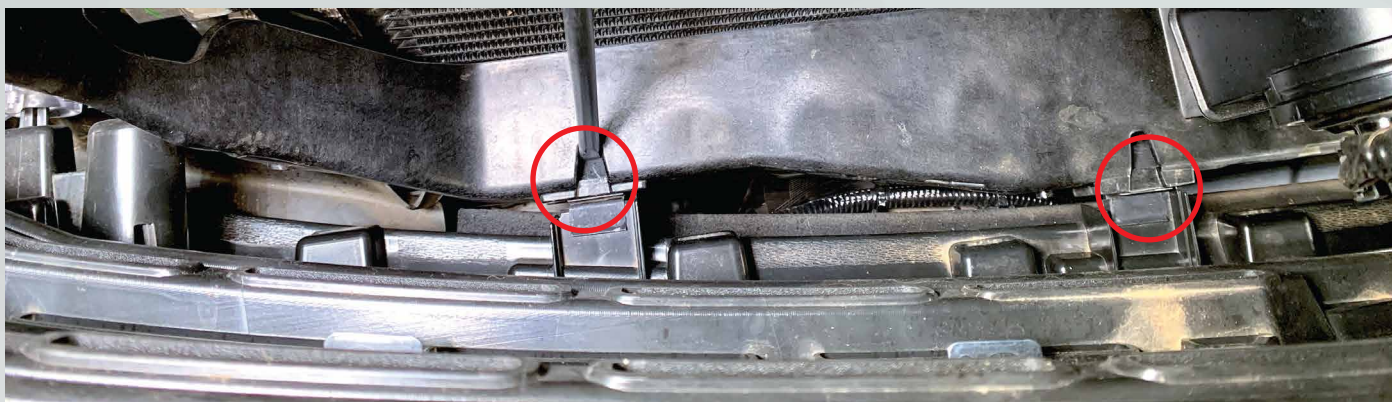

8. If you have a front camera, unplug the connector on the camera by pressing the release tab and sliding the connector off. Then disconnect the washer fluid hose fitting by prying up on one side of the locking collar then slide the hose fitting off (A few drops of washer fluid may come out.). Now pull the grille off of the truck and set it aside.



9. Remove one (1) 13mm bolt holding the bottom tab of the passenger side headlight to the fender (IMAGE 1). Remove two (2) 10mm bolts holding the top of the headlight (IMAGE 2).

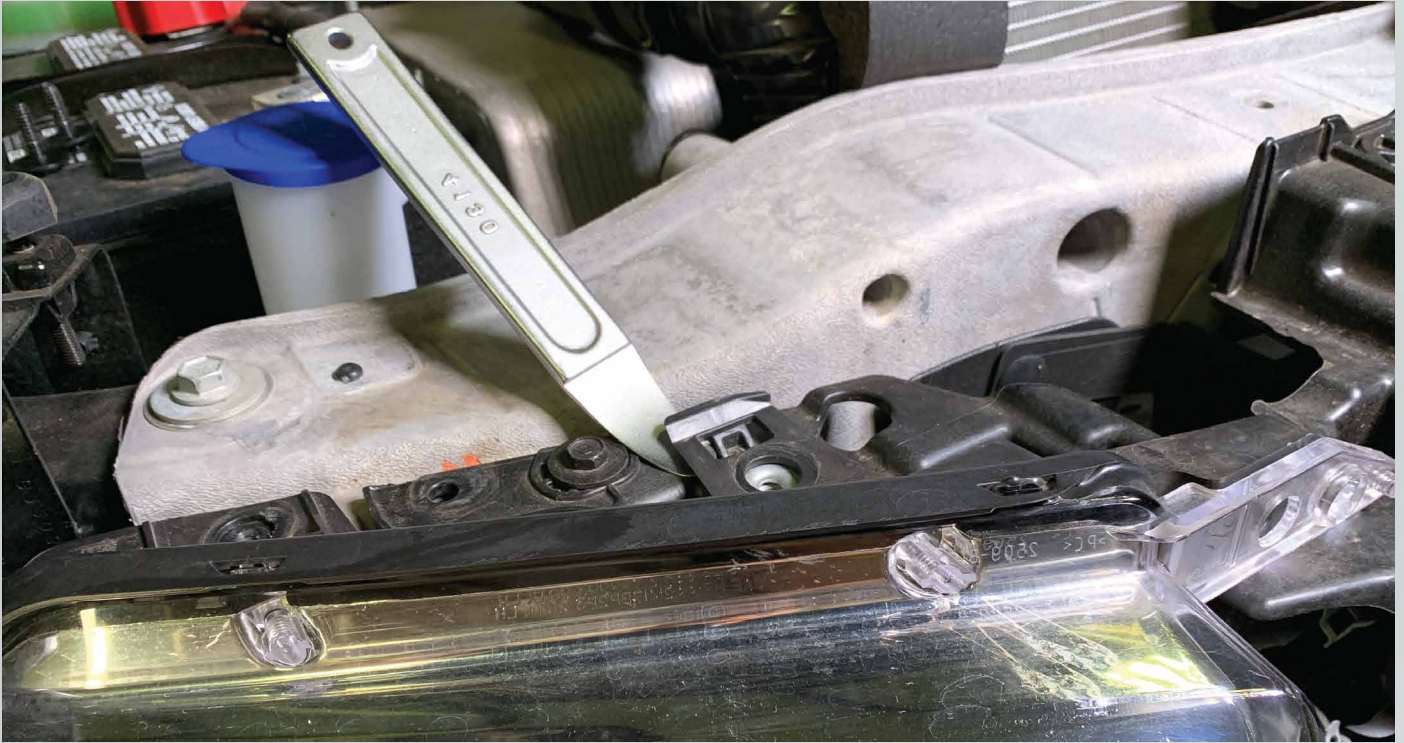

IMAGE 1

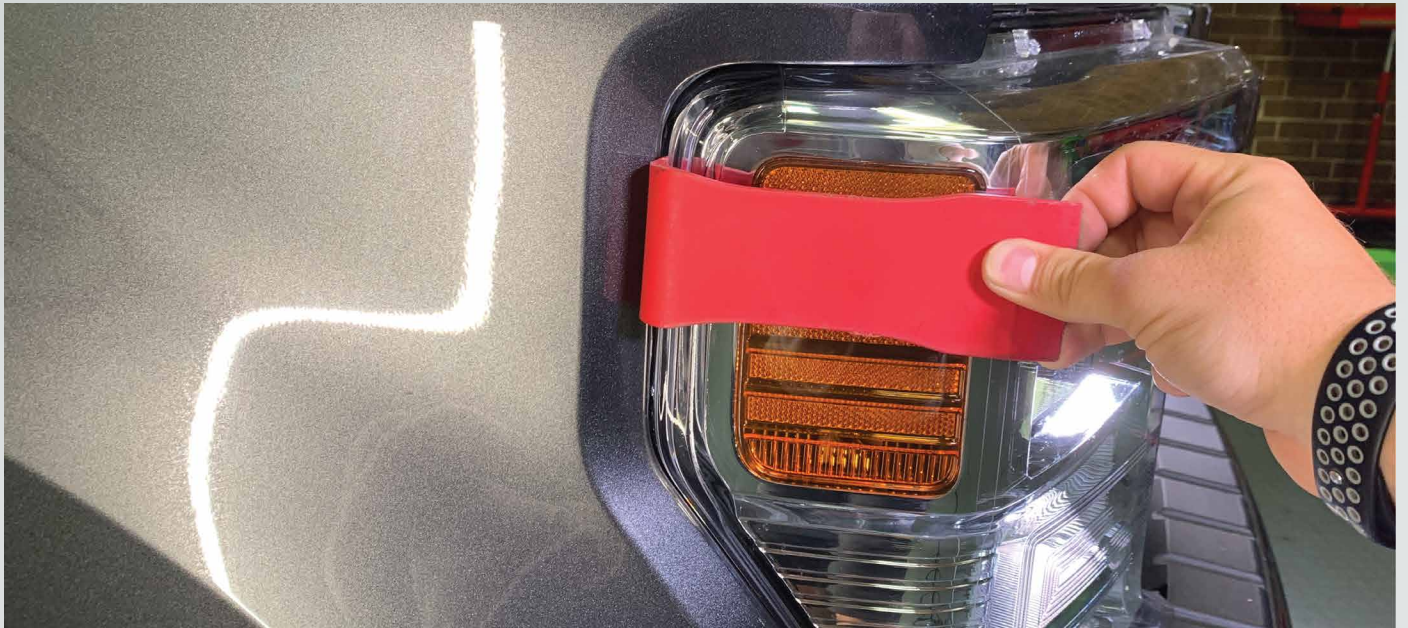

IMAGE 2

10. Pry up on this tab to release the top of the headlight.



11. With a plastic pry tool, pry the side of the headlight away from the fender to release it.



INSTALL MORIMOTO XB HEADLIGHTS ON A OEM LED TRUCK



PACKAGE CONTENTS (IF ORDERED OPTIONAL LF508H-LED HARNESS)



2 X LIN BUS MODULE



1 X CROSSOVER HARNESS



1 X BATTERY HARNESS

INSTALL ON OEM LED TRUCK WITH KEEPING YOUR
OEM LED HEADLIGHTS SKIP TO PAGE 24

12. Slide the passenger headlight forward. Unplug the multi pin connector (IMAGE 3), and repeat on the other side of the truck. Locate the included Fuse Tap DRL harness (the one included with the headlights) and remove the 10A fuse shown in IMAGE 4.a. Replace that fuse with the 15A fuse included with your Morimoto grille (IMAGE 4.b).

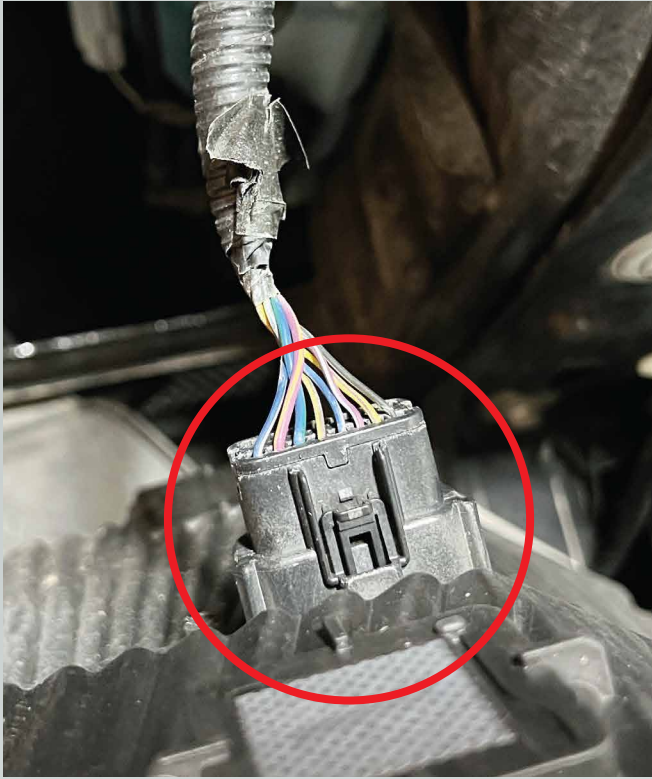

IMAGE 3

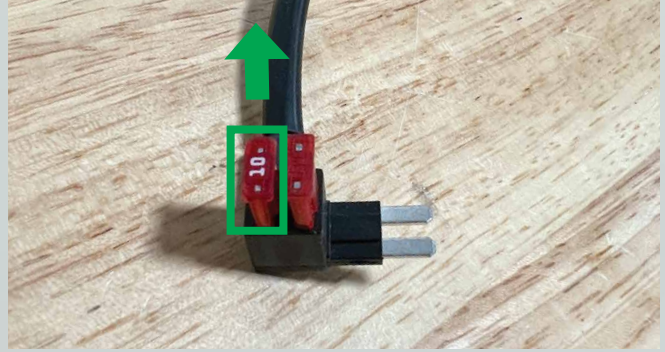

IMAGE 4.a

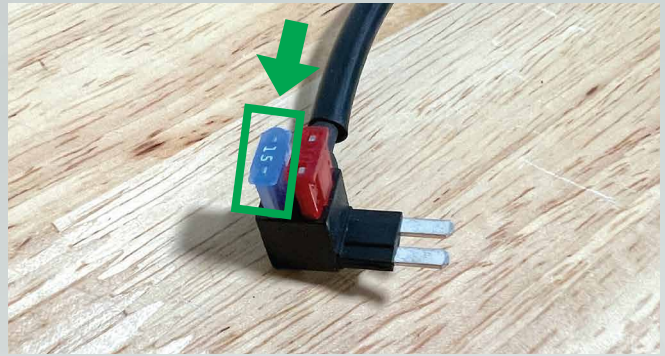
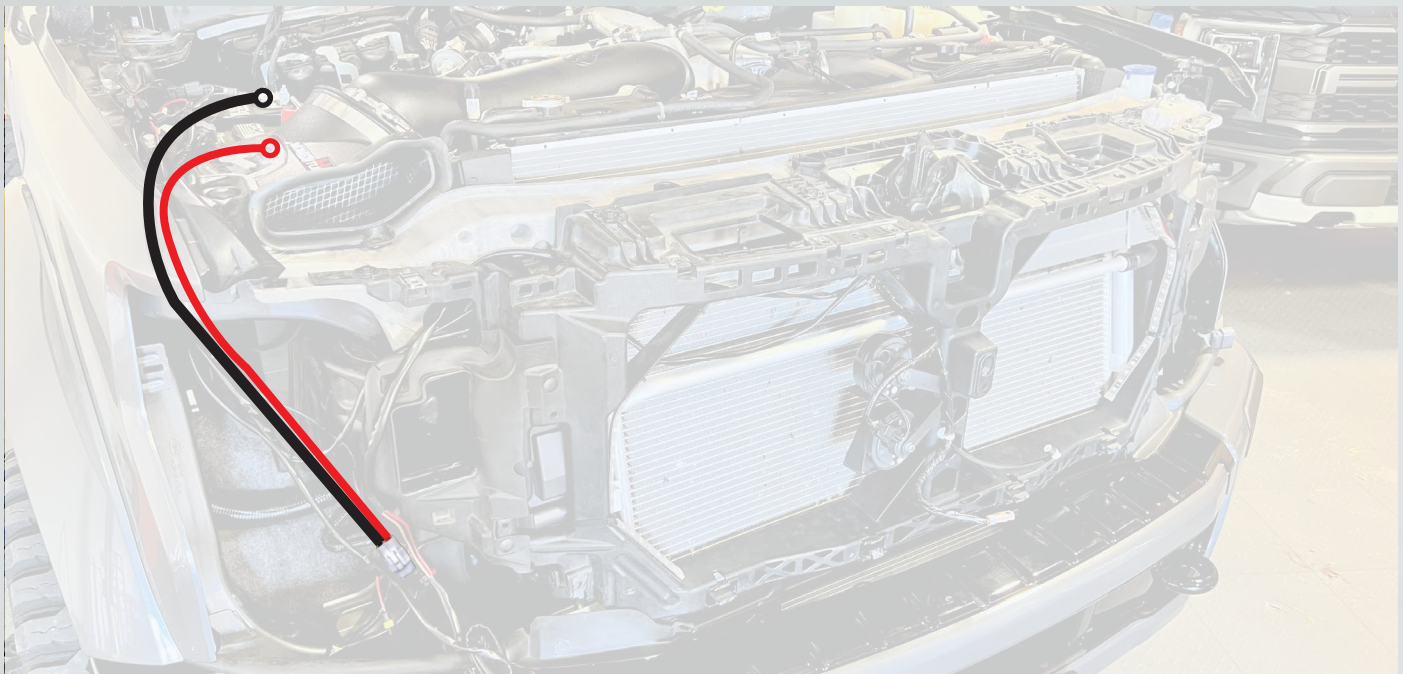
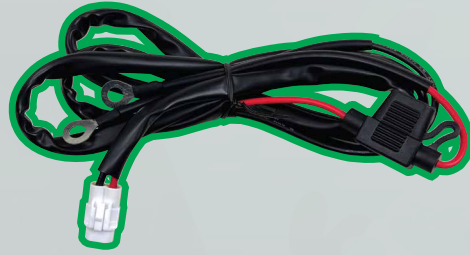

IMAGE 4.b

13. Locate the under hood fuse box located by the firewall on the passenger side of the truck and remove the cover. Remove fuse #16. Get the DRL harness from the previous step. Plug in the fuse side of the harness into fuse slot #16. Run the short side of the harness to the passenger headlight area and run the long side to the driver headlight area.



14. -Locate the included Battery Harness, go to the battery and remove the 10mm nut on the positive terminal. Install the positive lead (red wire) onto the stud on the positive terminal, and reinstall the 10mm nut.
-Install the negative lead from the Battery Harness (black wire). Remove the 10mm nut on the negative terminal, install the negative lead (black wire) and reinstall the 10mm nut.
-Run the other end of the Battery Harness to the passenger side headlight opening.



15. Locate the included Crossover Harness.

- Starting on the passenger side of the vehicle, place the end of the harness, that has 2 connectors, in the passenger headlight opening.
- Then route the other side of the harness to the driver side headlight opening.



(HARNESS ROUTING)

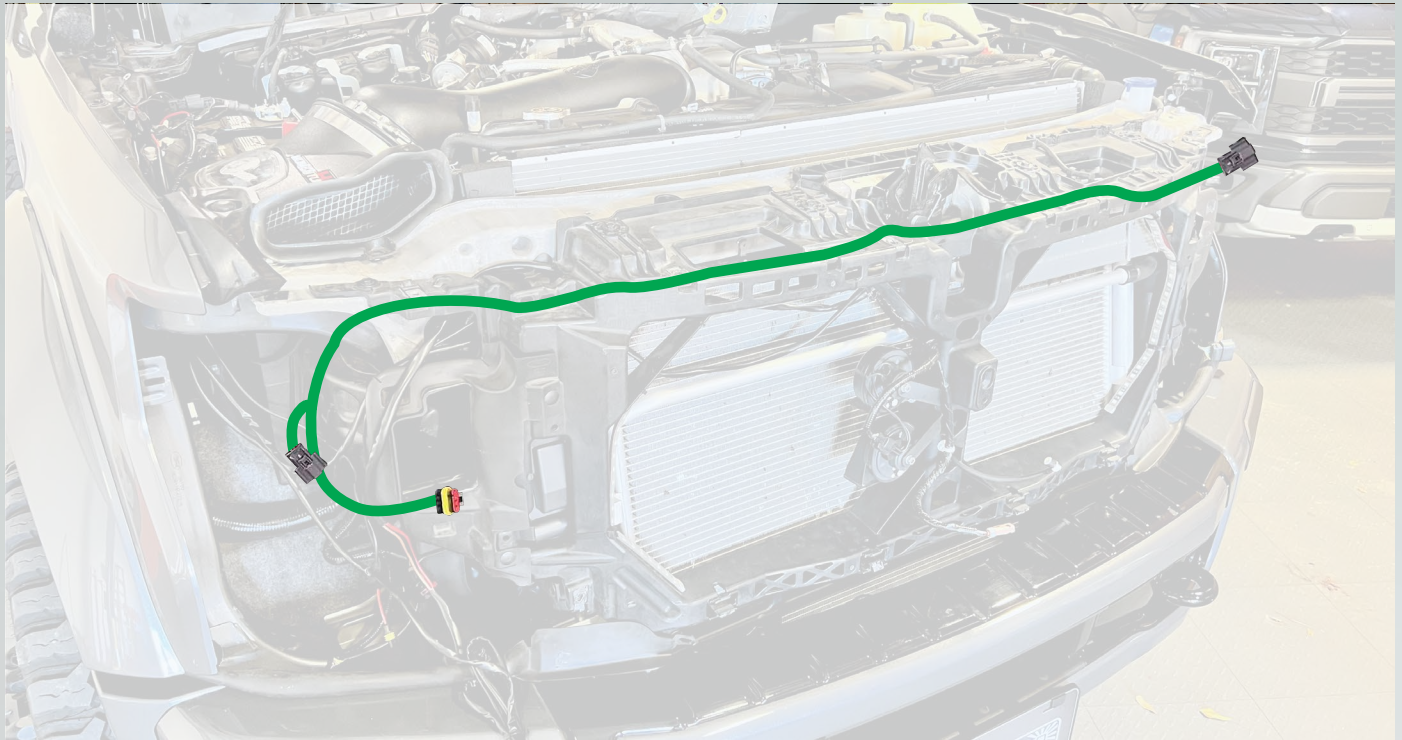

16. Locate the LED Adaptor Harness that is included with the grille.
- On the passenger side of the truck, plug in the adaptor into your truck wiring and the DRL harness.
 - Route the grille wiring toward the center of the grille.

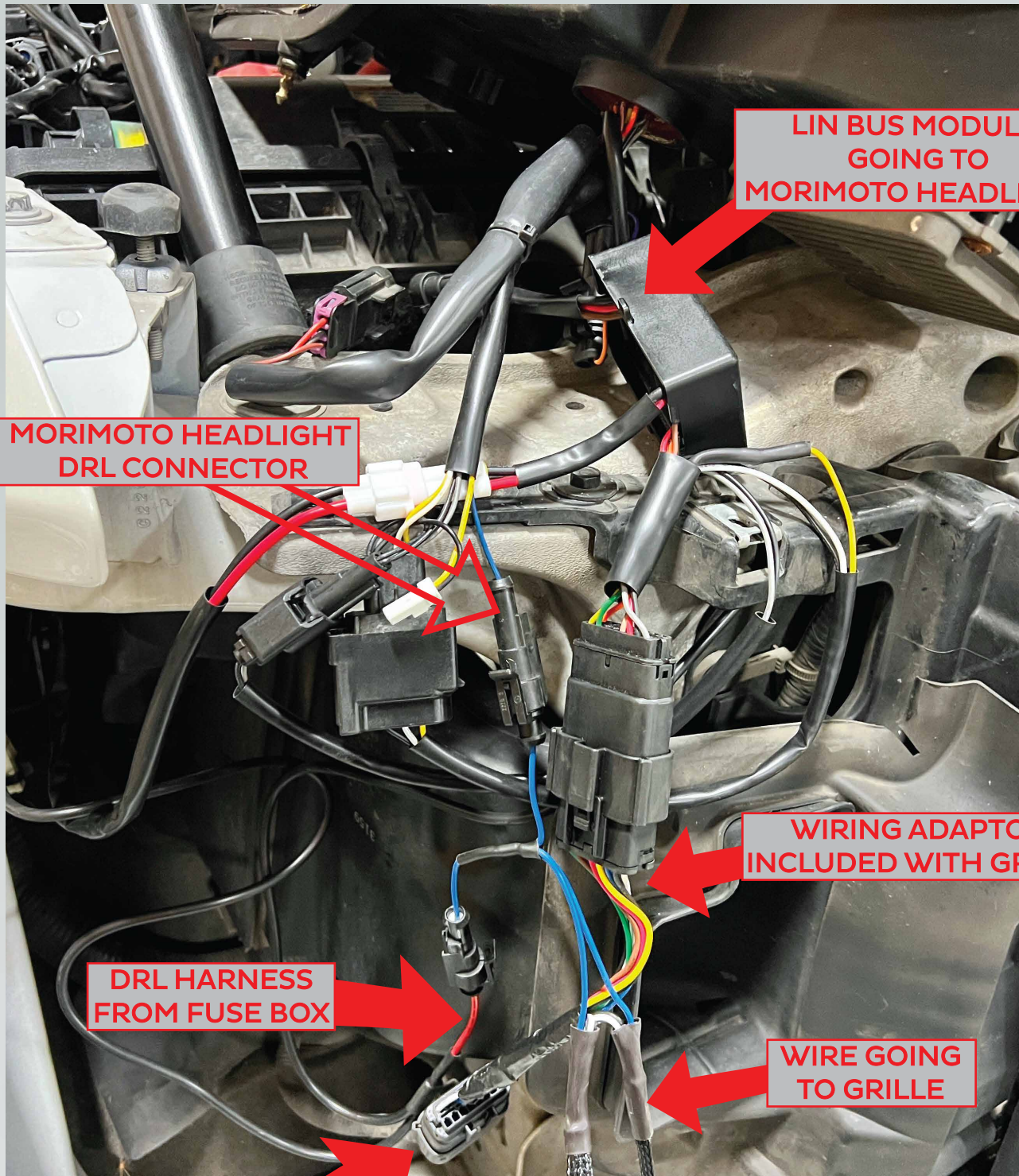

**LIN BUS MODULE
GOING TO
MORIMOTO HEADLIGHT**

**MORIMOTO HEADLIGHT
DRL CONNECTOR**

**WIRING ADAPTOR
INCLUDED WITH GRILLE**

**DRL HARNESS
FROM FUSE BOX**

**WIRE GOING
TO GRILLE**

OEM HARNESS FROM TRUCK

**OEM LED TRUCK USING
MORIMOTO XB HEADLIGHTS**

17. Get the passenger side included Lin Bus module. Start by plugging in these two (2) connectors (IMAGE 5). Plug in the Crossover Harness into the Lin Bus module (IMAGE 6).

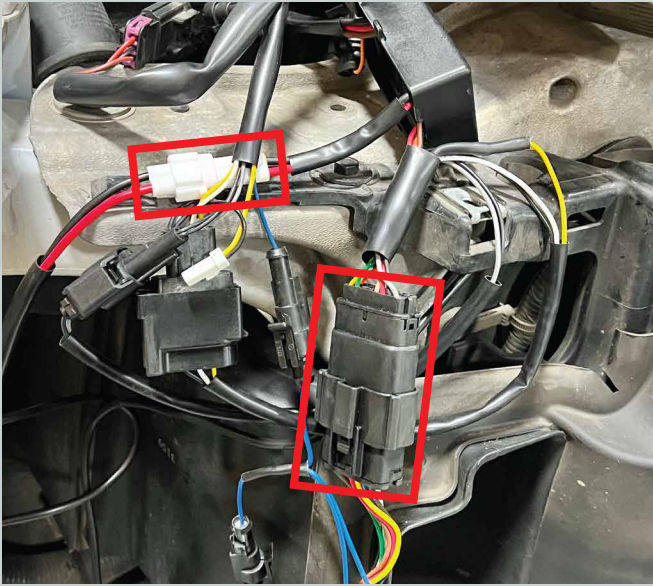

IMAGE 5

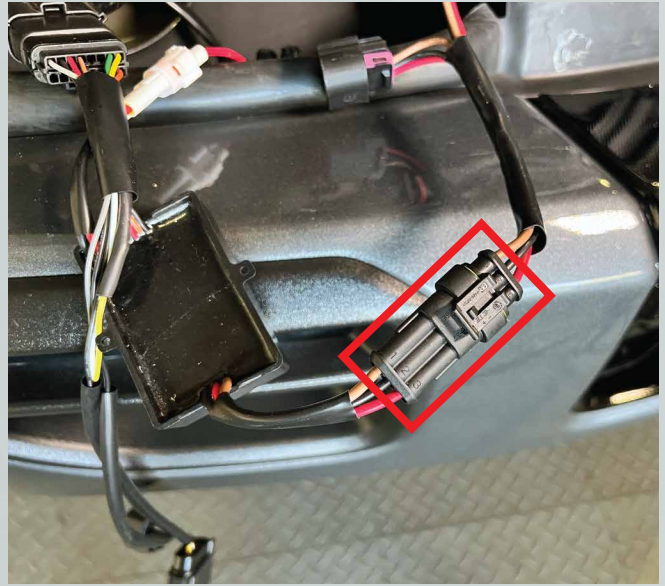

IMAGE 6

18. Grab your passenger side Morimoto headlight, bring it to the truck and plug in these two (2) connectors (IMAGE 7). Next plug in the DRL harness and the Crossover harness to the headlight (IMAGE 8).

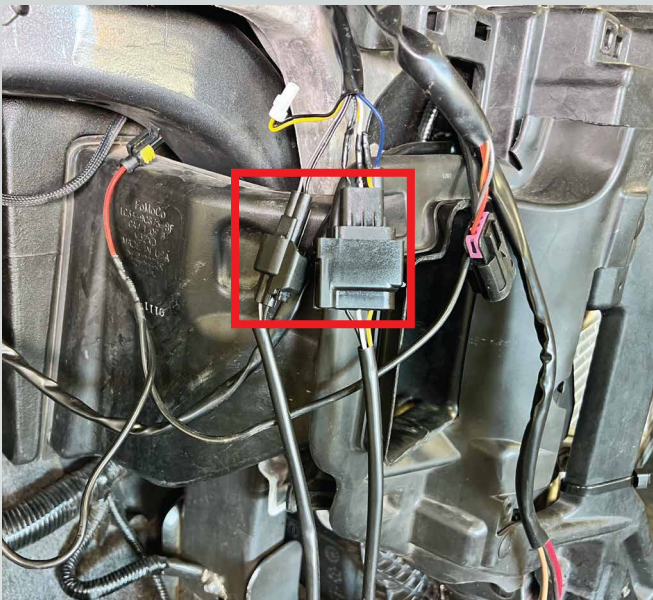

IMAGE 7

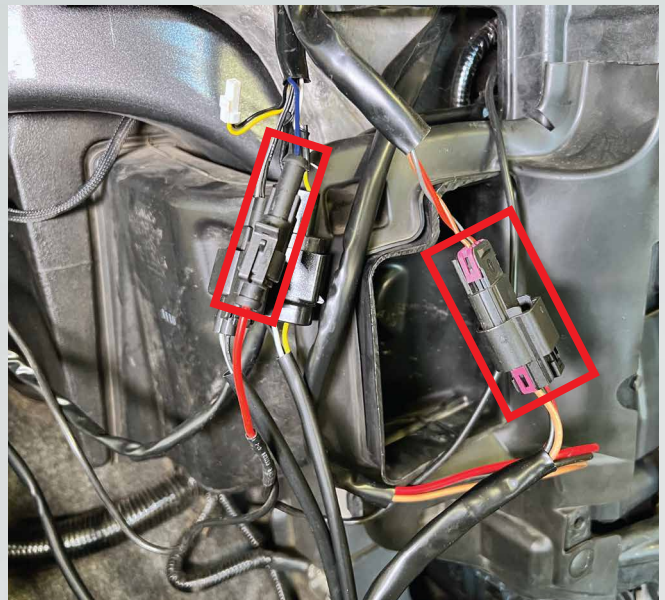
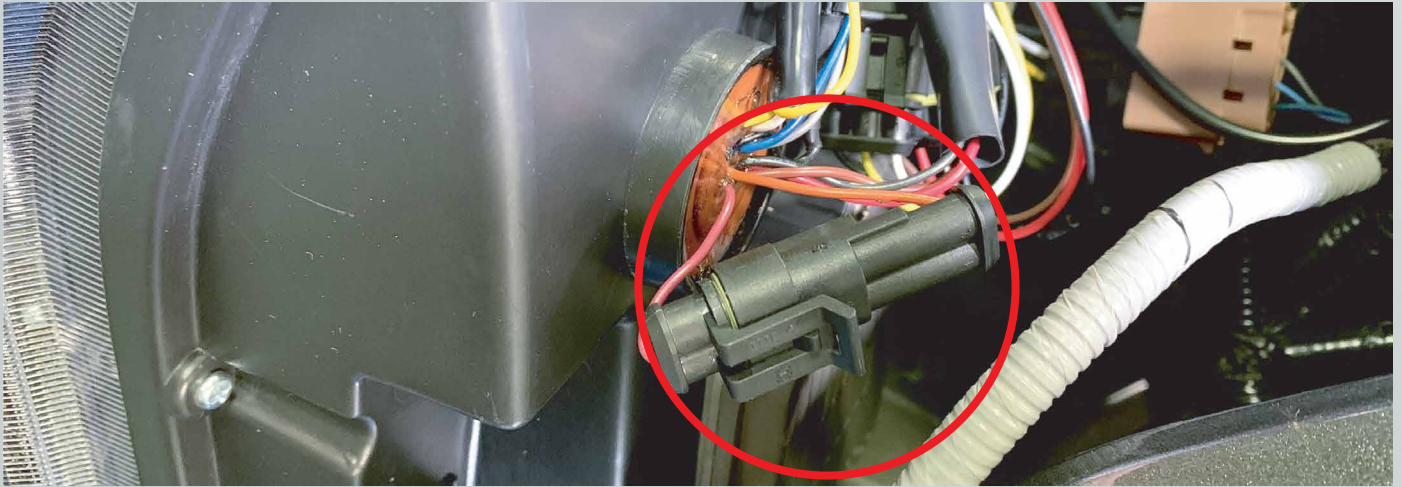

IMAGE 8

19. Slide the headlight into its mounting location making sure none of the wiring in the rear is getting pinched. Thread in the top bolts by hand.

20. Toggle between standard and sequential turn signal with this connector. Leave the connectors plugged in for a sequential turn signal. Leave the connectors unplugged for a standard turn signal.



21. Get the driver side included Lin Bus module and take it to the truck. Start by plugging in the multi pin connector (IMAGE 9). Get your driver side headlight and plug in these two (2) connectors (IMAGE 10). Plug in the Crossover Harness and DRL harness into the Lin Bus module (IMAGE 11).



IMAGE 9

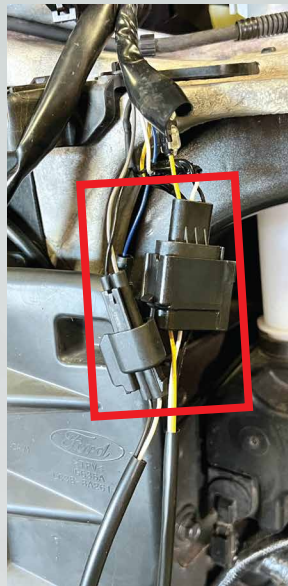

IMAGE 10



IMAGE 11

22. Slide the headlight into its mounting location making sure none of the wiring in the rear is getting pinched. Thread in the top bolts by hand.

SKIP TO PAGE 18 TO CONTINUE THE INSTALL

INSTALL ON OEM LED TRUCK W/ OEM HEADLIGHTS



23. Complete steps #1-11. Slide the headlight forward. Unplug the multi pin connector, to do so press the release tab and pull the connector off.



24. Locate the fuse box under the hood on the passenger side, by the firewall and remove fuse #16. Find the included fuse tap harness and plug it in place of the fuse you just removed. Route the end of the harness to the passenger side headlight area.

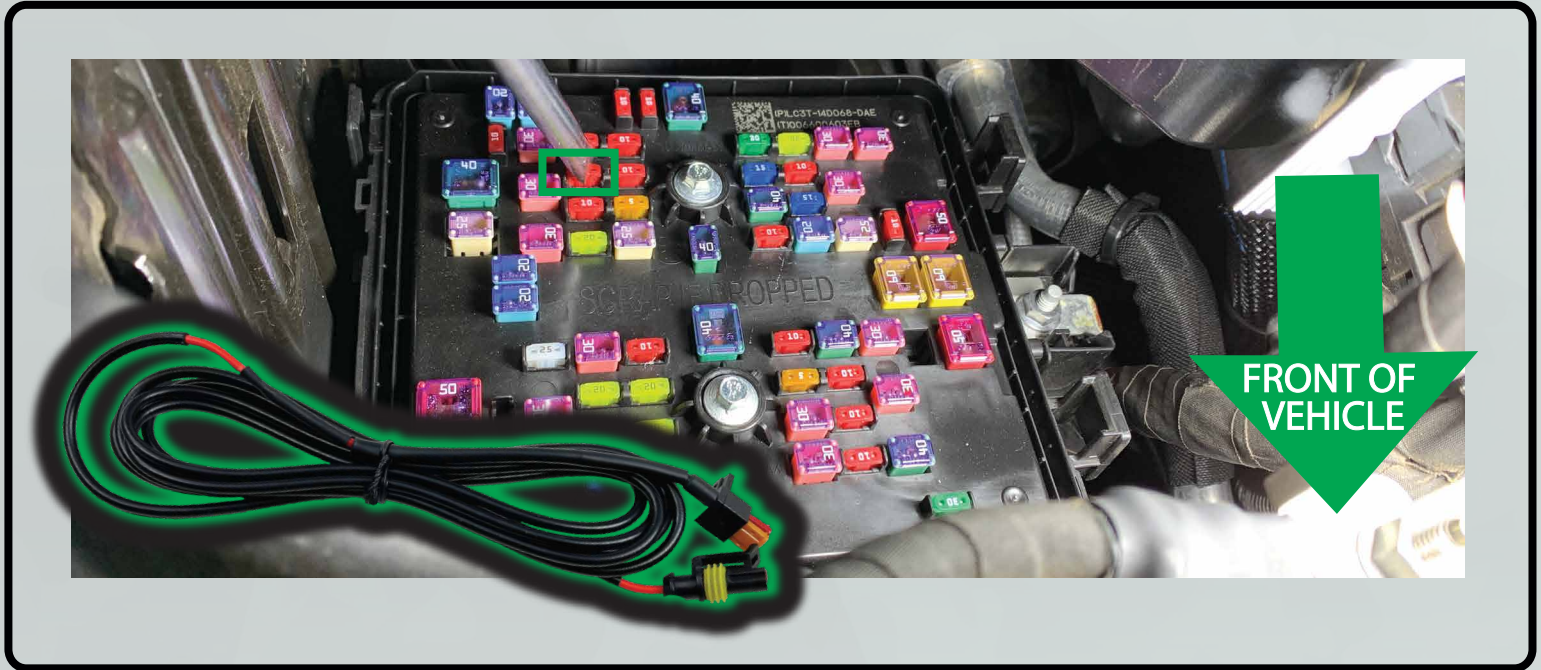

25. Locate the LED Adaptor Harness that is included with the grille.
- On the passenger side of the truck, plug in the adaptor into your truck wiring and the DRL harness.
- Route the grille wiring toward the center of the grille.

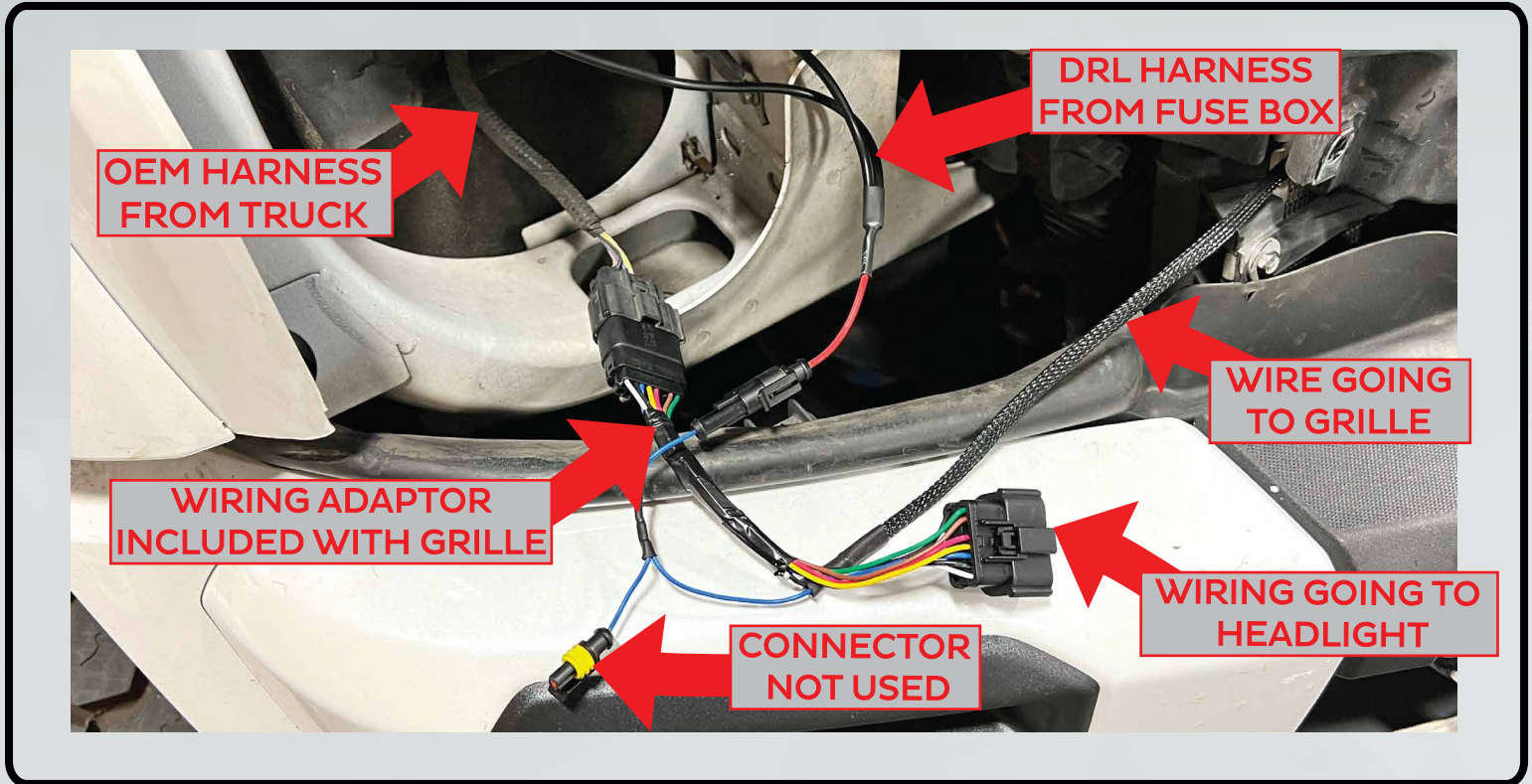

26. Get your oem headlight and plug the LED Adaptor harness into the headlight.

27. Slide the headlight into its mounting location making sure none of the wiring in the rear is getting pinched. Thread in the top bolts by hand.

DISASSEMBLE OEM GRILLE

28. To remove the trim pieces off of your OEM grille, start by facing the back of the grille towards you. With a flat head screwdriver pry the little locking clip away from the locked position (#1). With light pressure push the tab to go through the hole in the grille (#2). Essentially you are pulling the trim piece away from the grille structure. Repeat this on each tab on the top and bottom of the grille making sure the the tabs don't relock themselves. Once you have release all the clips, the trim piece should slide out.

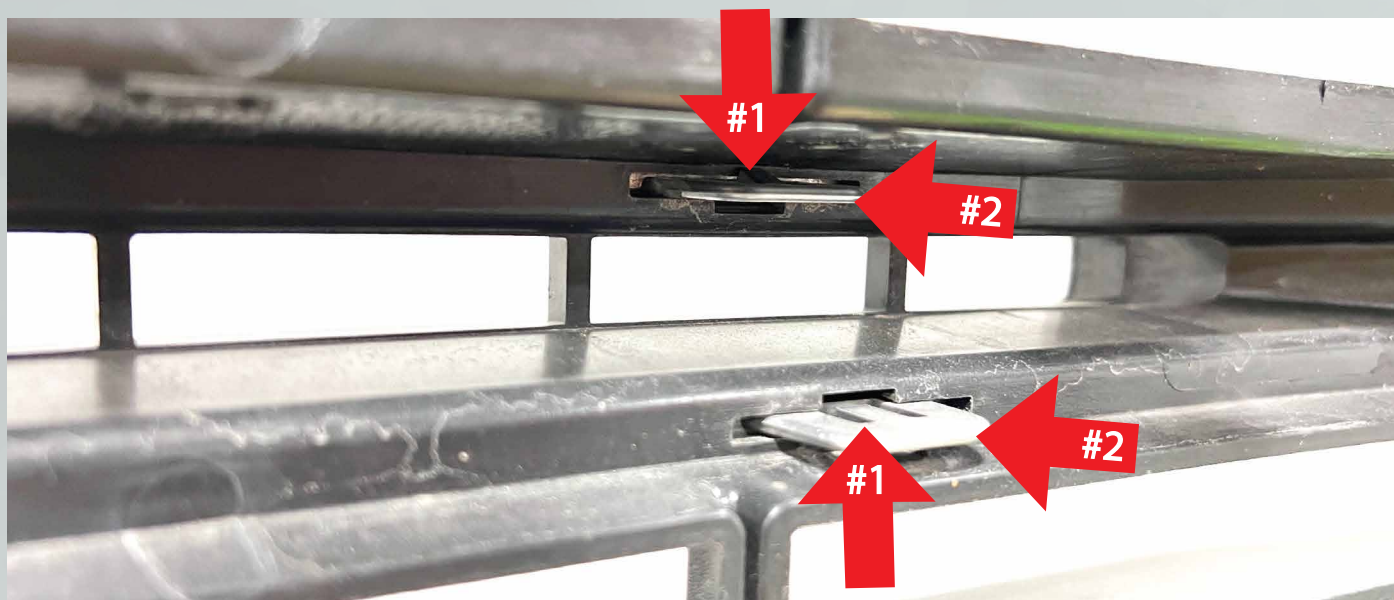

-Here are the locations of the tabs for the upper and lower trim pieces.

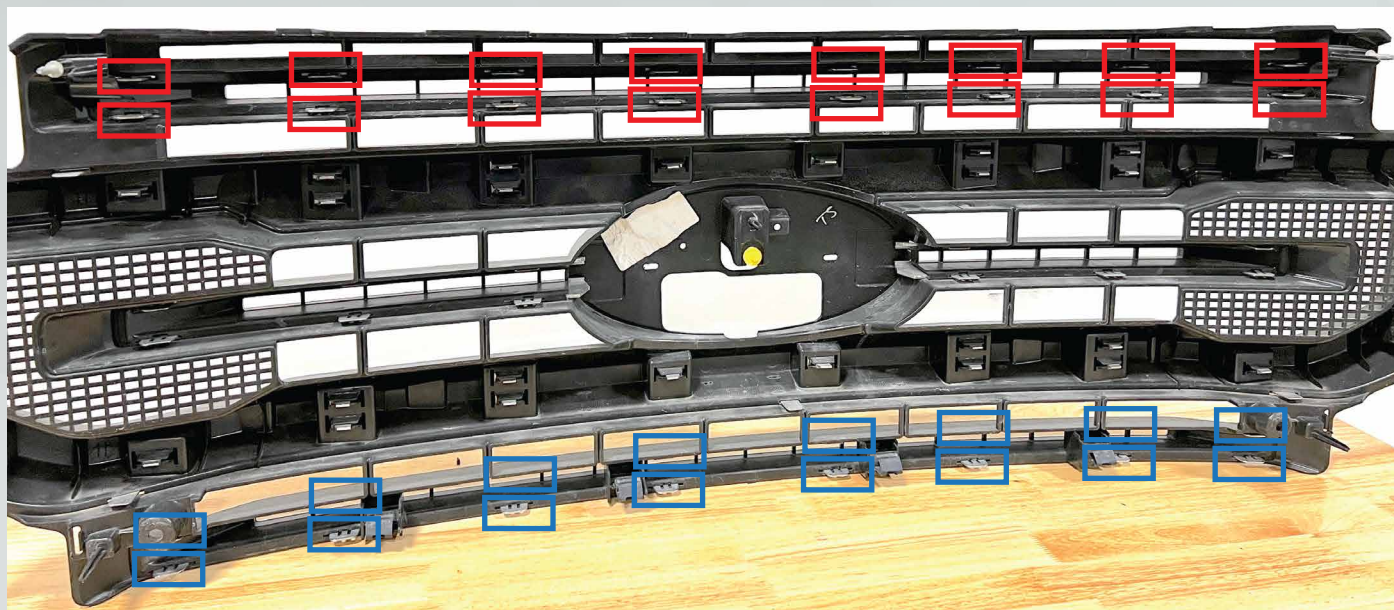

29. Take your Morimoto grille light bar and route the wiring through this hole in your grille. Do this on the top and bottom led strip.

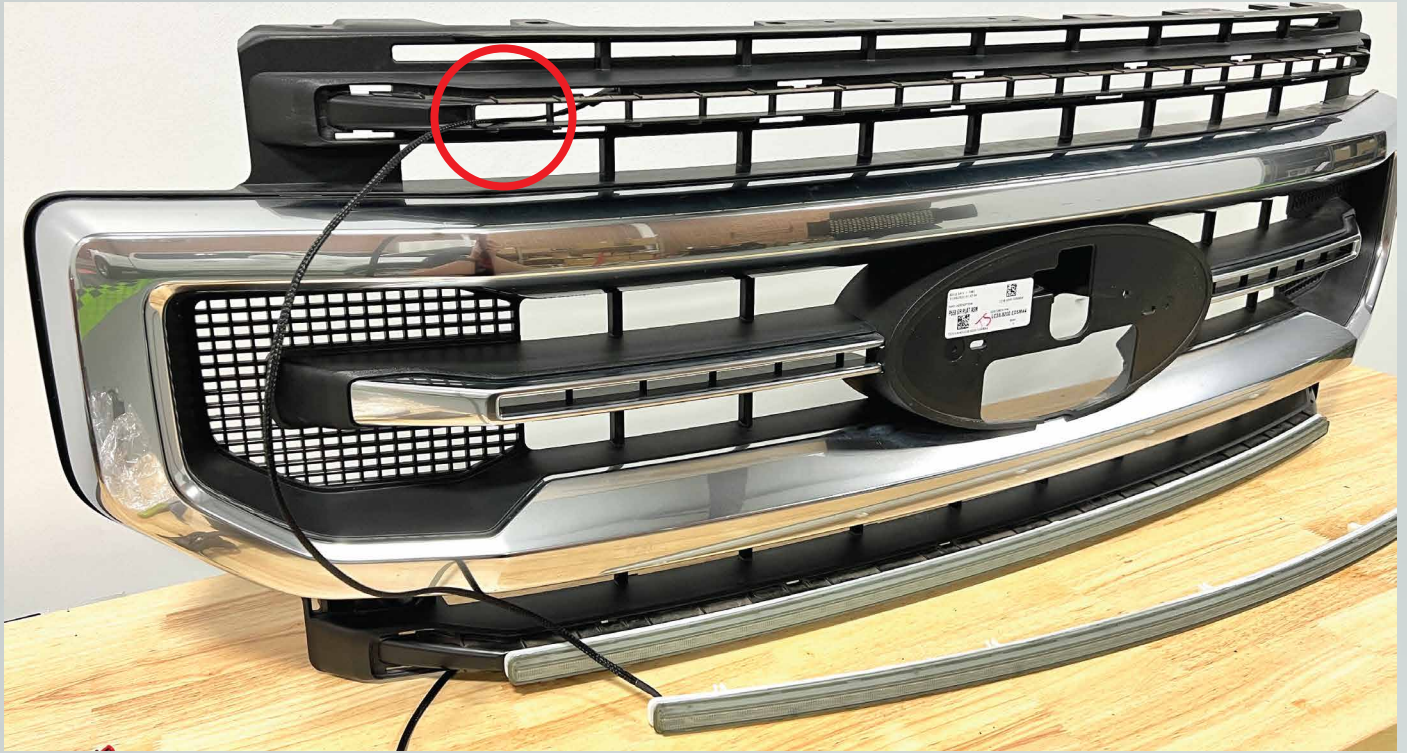

30. Align the clips on the back of the light bars with the vertical strips on the grille and push the light bar into the grille so that the clips lock in. Repeat this on all of the clips.

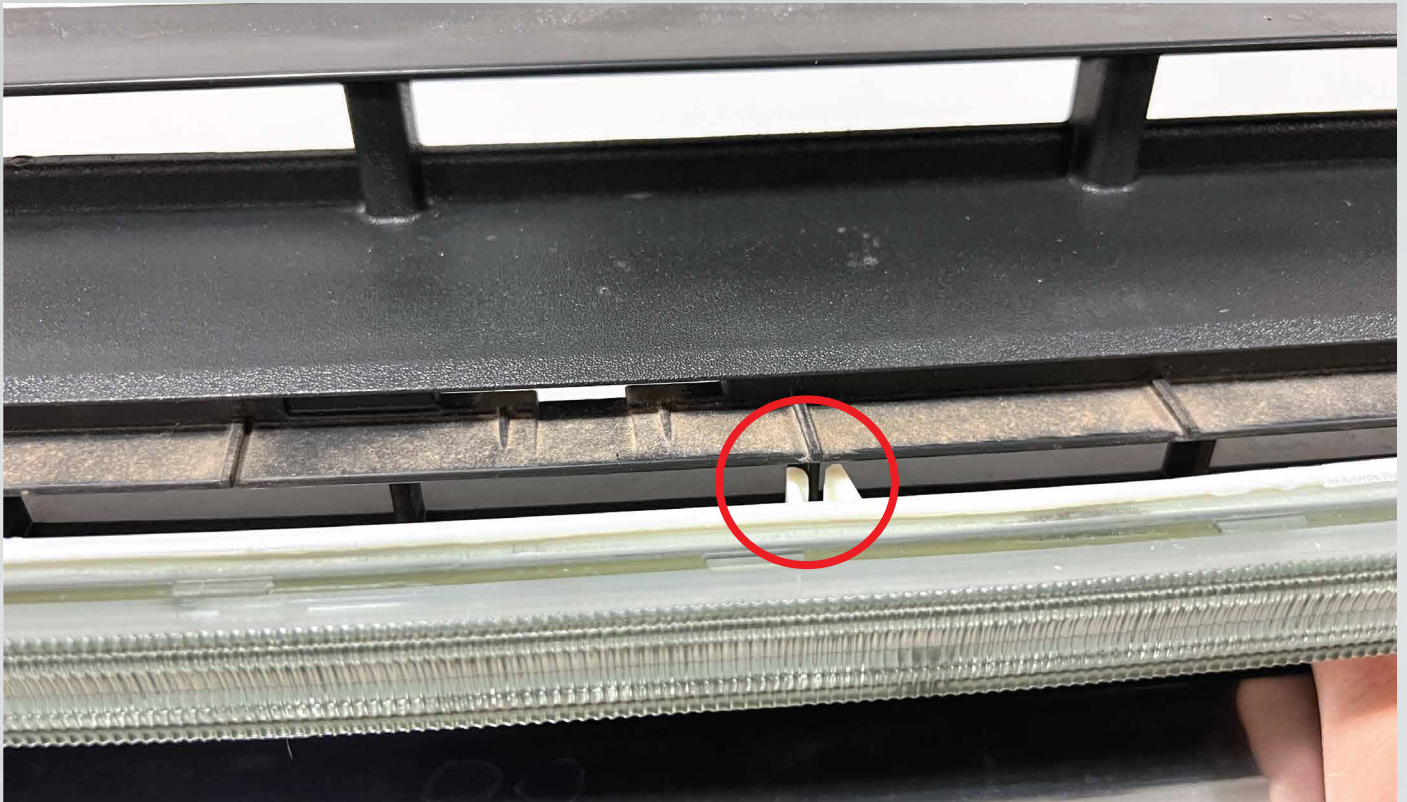

31. Take your new trim pieces and locate the top, line up all of the tabs with the holes in the grille. Firmly press the trim down to lock into the grille. Repeat this on the bottom trim piece.

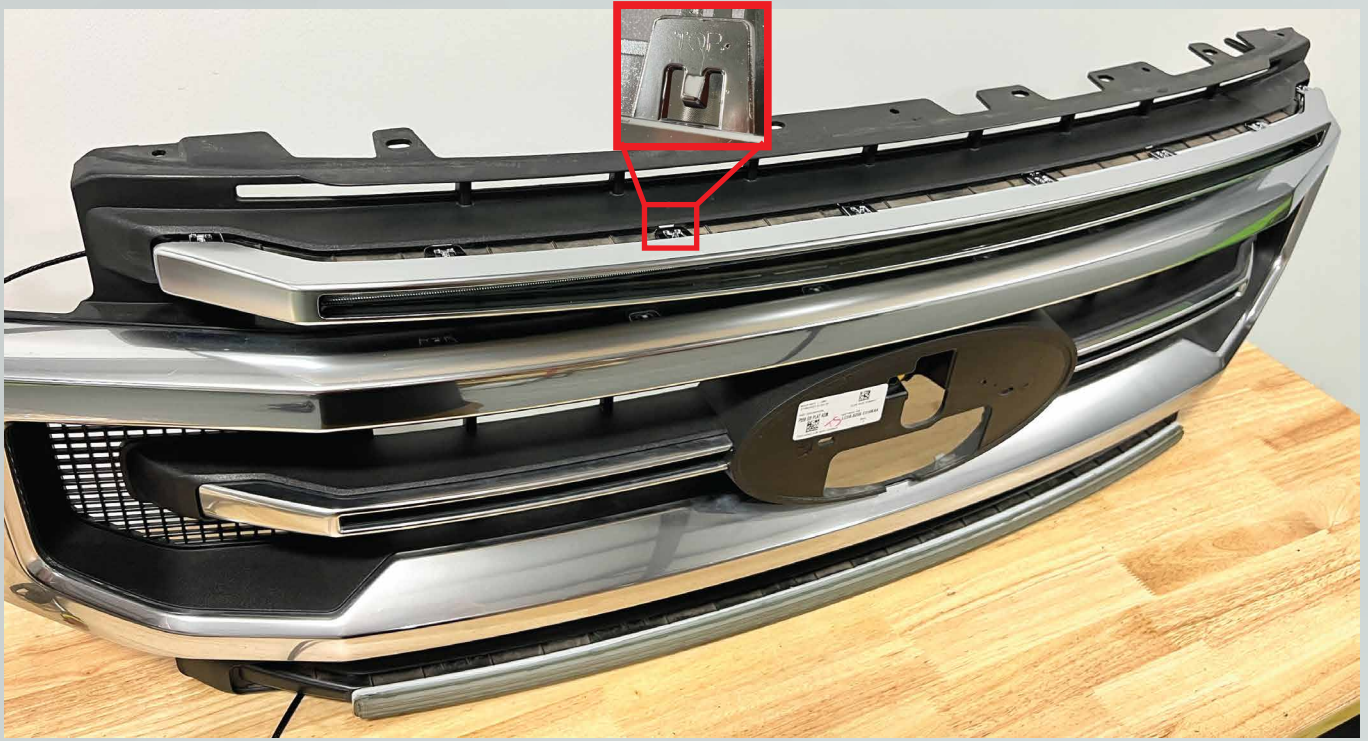

32. Route the wires on the back of the grille as shown below and secure the wires with the supplied zipties. (arrows indicate ziptie locations)

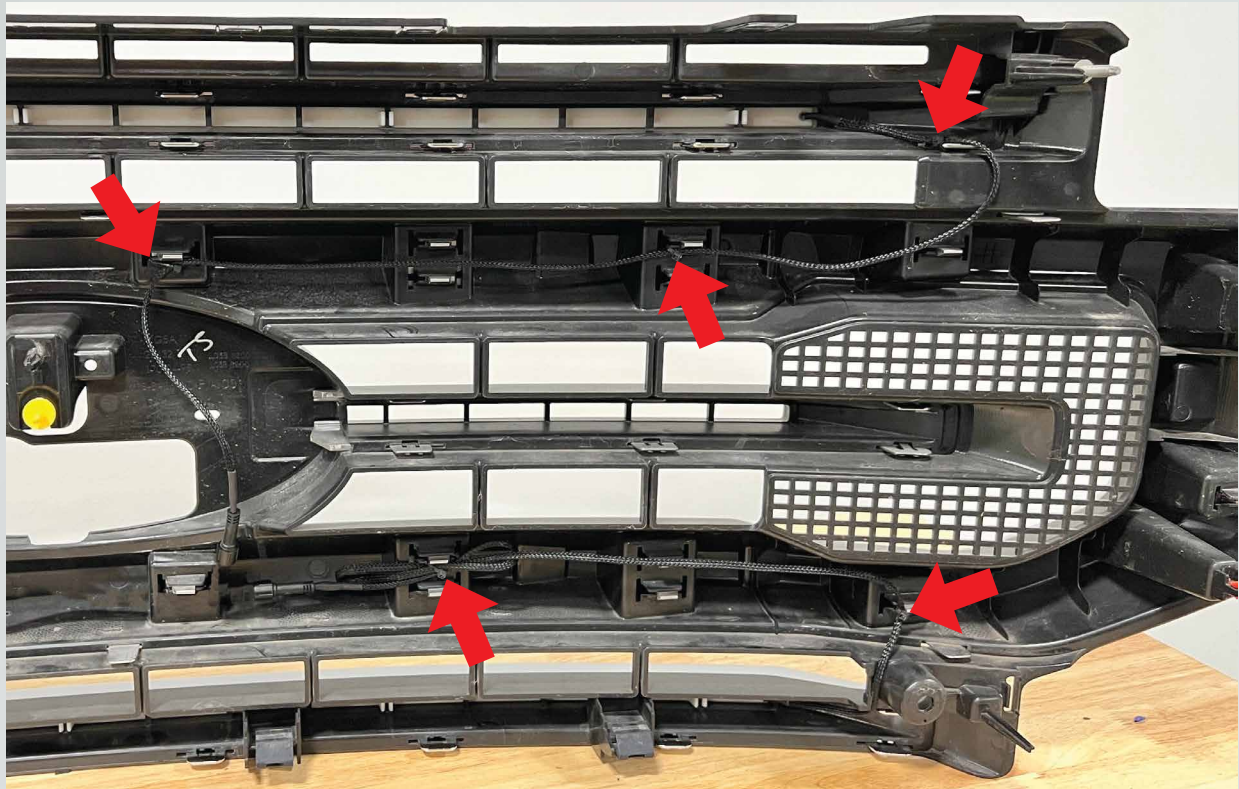

33. To mount the LED Driver, first insert the long zipties into the core support in the location shown below. Then with the supplied Prep Pad wipe the area clean (IMAGE 12). Get the LED Driver and peel back the backing of the double sided tape (IMAGE 13).

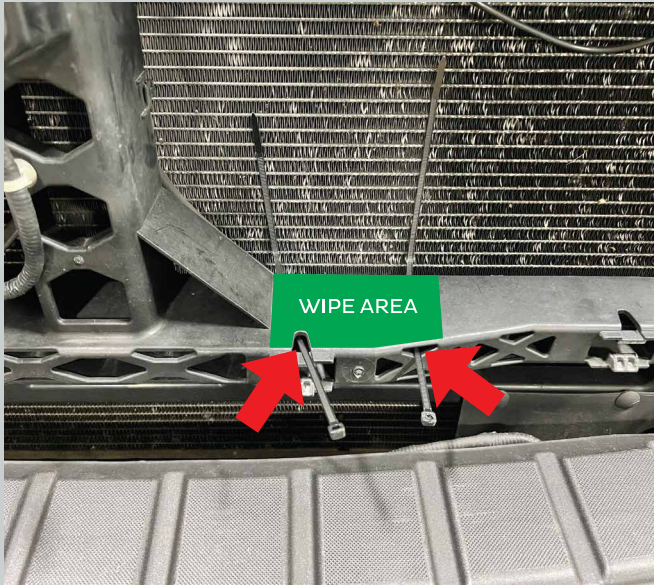

IMAGE 12

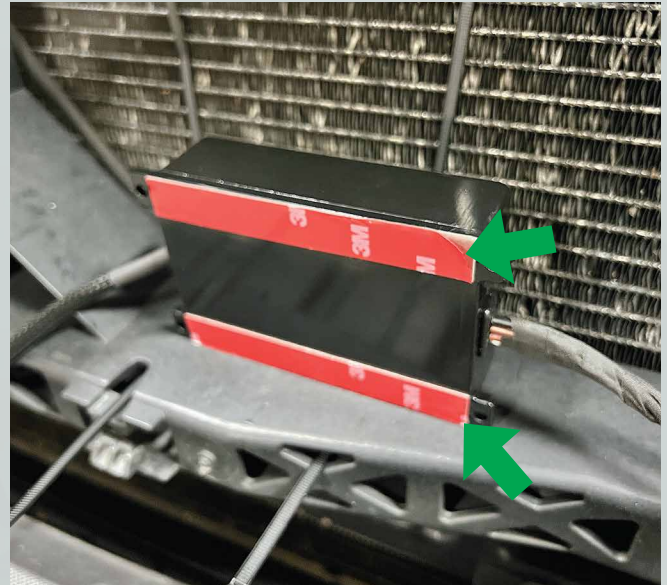

IMAGE 13

34. Place the LED Driver on the radiator support and secure it in place with the zipties (IMAGE 14). Connect the LED Driver wiring with Grille Adaptor Harness coming from the headlight area (#1)(IMAGE 15). Bring your grille to the truck and make the two (2) connection between the grille (#2)(IMAGE 15). Make sure to line up the arrows on the connectors before plugging them into each other then thread on the locking collar.



IMAGE 14

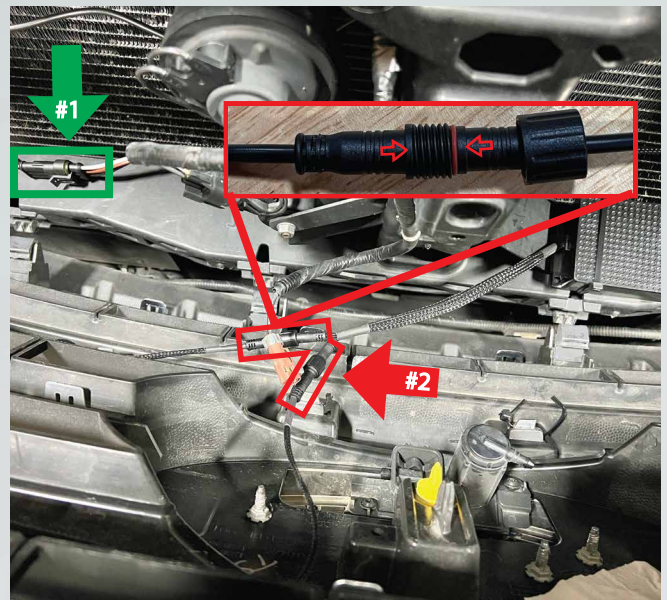

IMAGE 15

35. Turn the truck on and test all of the functions to make sure everything works.

36. Reassemble the truck in the reverse order that you took it apart.

PROCEED TO PAGE 3 FOR HEADLIGHT AIMING INSTRUCTIONS