

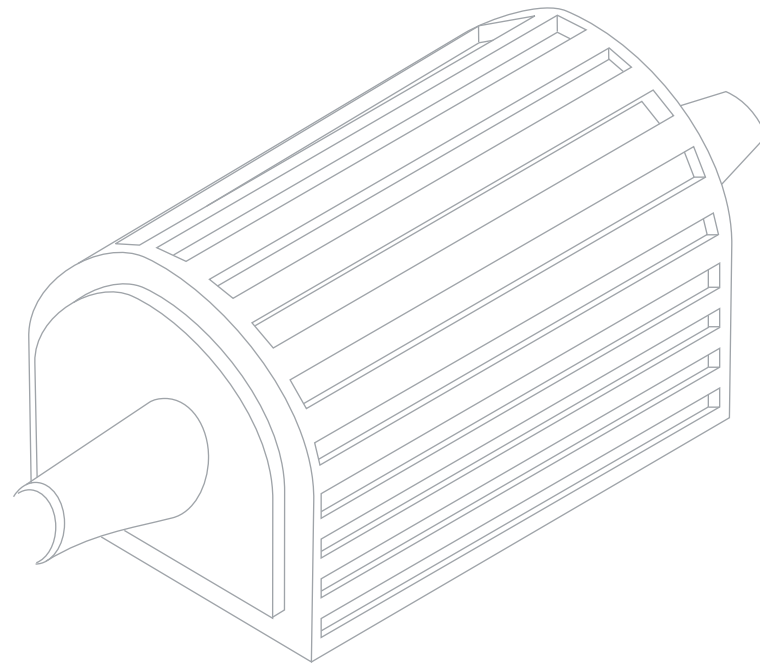

THE AUTOMOTIVE LIGHTING BENCHMARK



INSTALLATION GUIDE

H4 SINGLE MOTORCYCLE HID SYSTEM



WARNING: By reading this document, I agree it is only to be used as an educational guide. Morimoto Lighting makes no guarantee on any finished results, nor are they to be held responsible for any damage, misuse, or personal injuries. Use at your own risk. If you are unable to clearly understand and adapt the information below to your own application, professional installation is recommended.

TABLE OF CONTENTS

SYSTEM DIAGRAMS

P.2

HARNESS INSTALLATION

P.5

BULB INSTALLATION

P.5

BALLAST INSTALLATION

P.6

STANDARD PARTS

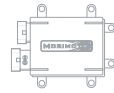

1X BALLAST COMPUTER



1X AMP IGNITER



1X BI-XENON BULB

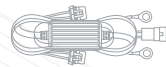

1X CYCLE-SPEC RELAY HARNESS



1X HIGH BEAM ADAPTER

OPTIONAL PARTS

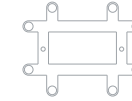

1X CARBON FIBER BALLAST BRACKET

SPECIAL NOTE



Morimoto MotoCycle wire harnesses are designed and built specifically for use on a motorcycle / scooter. Wire lengths of the harness are configured so that the harness control module can fit under the seat next to the bike's battery. The output and input of the harness are elongated to receive and send signal from the OEM headlight connector at the front of the bike without splicing or modification.



SYSTEM DIAGRAMS



NOTE: System diagrams are to be used for reference purposes only. If you are unsure of the installation procedure for any individual part, review its install procedure prior to proceeding.

SYSTEM DIAGRAM

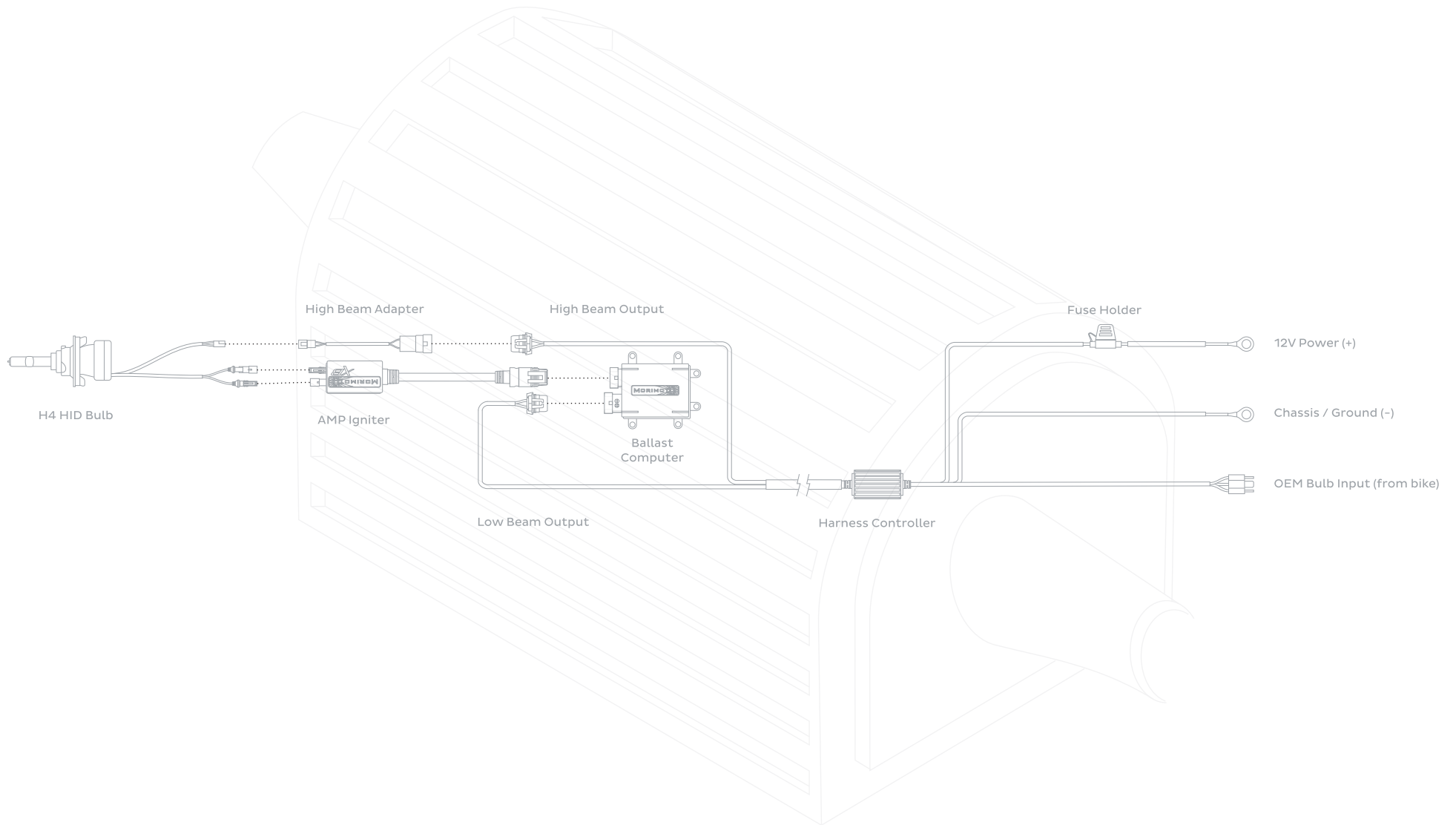

HARNESS INSTALLATION



WATERPROOF

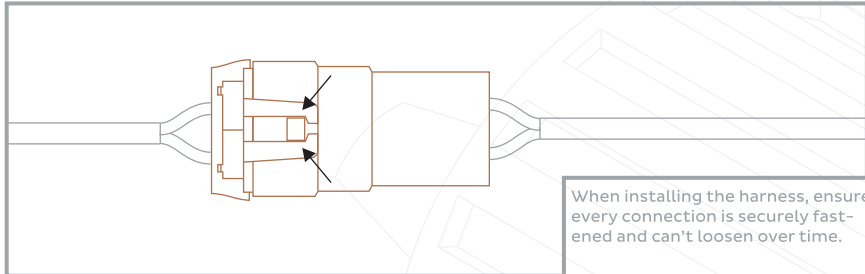

When installing the harness, ensure every connection is securely fastened and can't loosen over time.

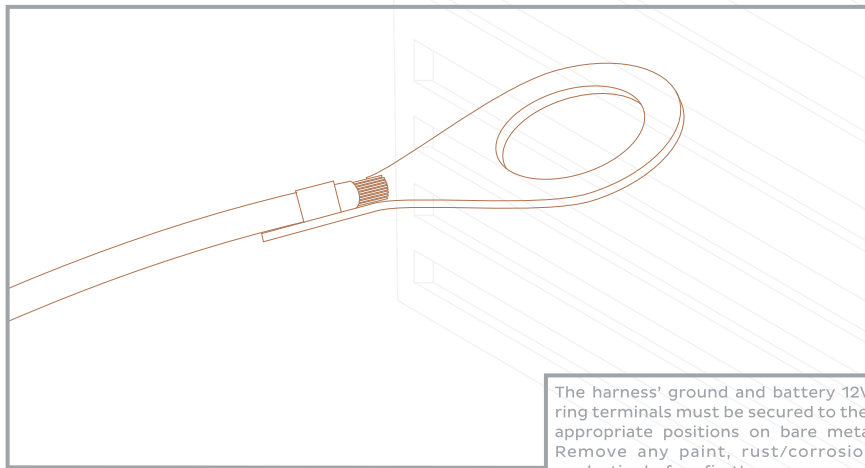

The harness' ground and battery 12V+ ring terminals must be secured to their appropriate positions on bare metal. Remove any paint, rust/corrosion, or plastics before first!

BULB INSTALLATION



CAUTION: HOT!



HANDLE ONLY WITH BLACK PLASTIC BASE

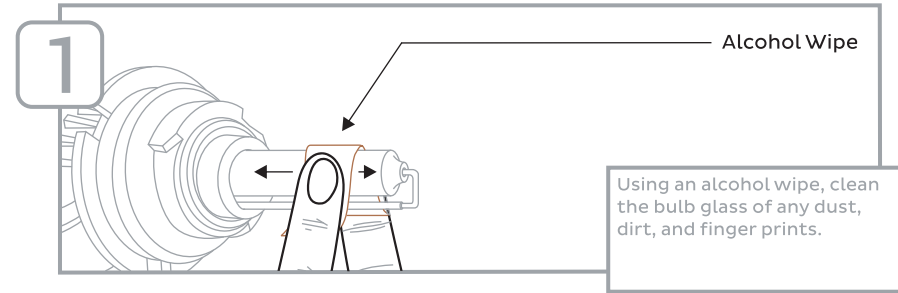

Using an alcohol wipe, clean the bulb glass of any dust, dirt, and finger prints.

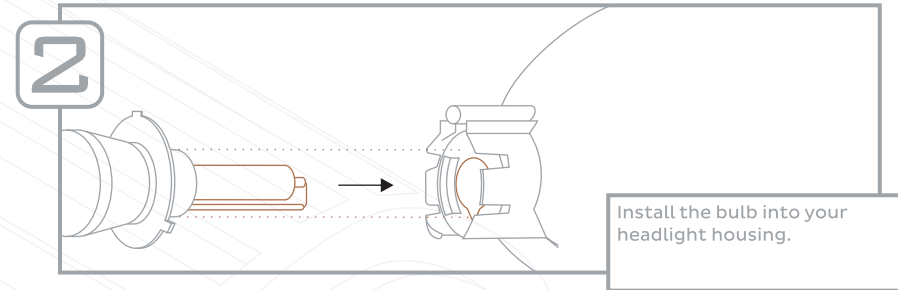

Install the bulb into your headlight housing.

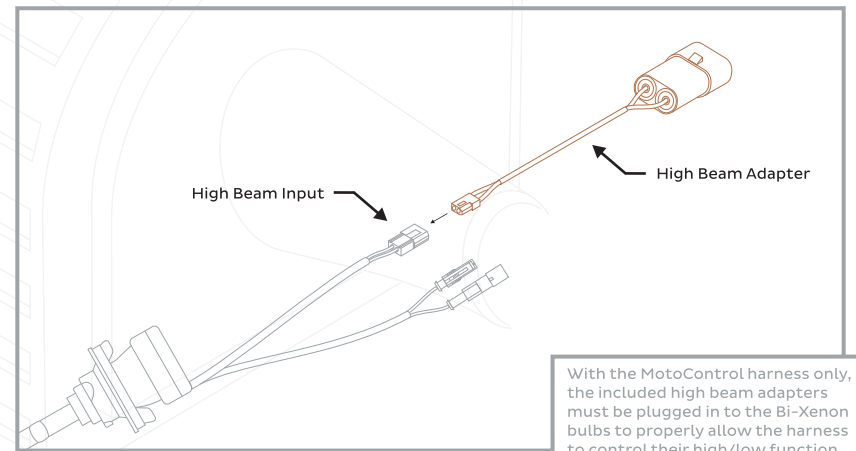

With the MotoControl harness only, the included high beam adapters must be plugged in to the Bi-Xenon bulbs to properly allow the harness to control their high/low function.

BALLAST INSTALLATION



DO NOT IGNITE UNTIL FULLY CONNECTED!



WATERPROOF

SCHEMATIC

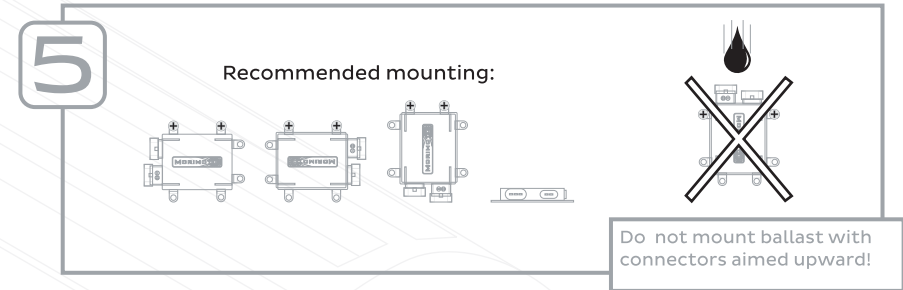
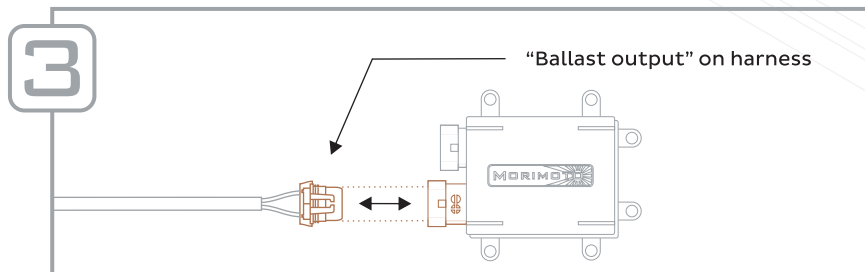
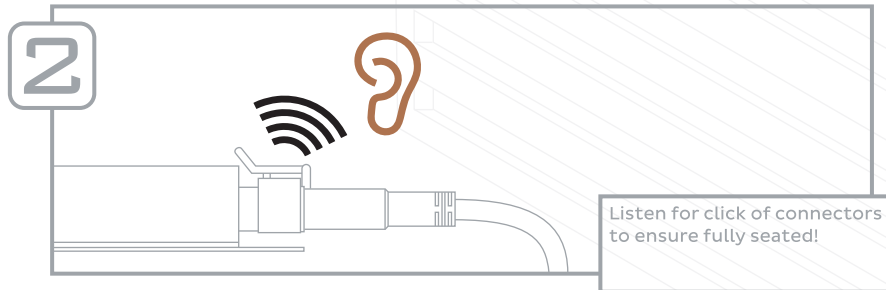
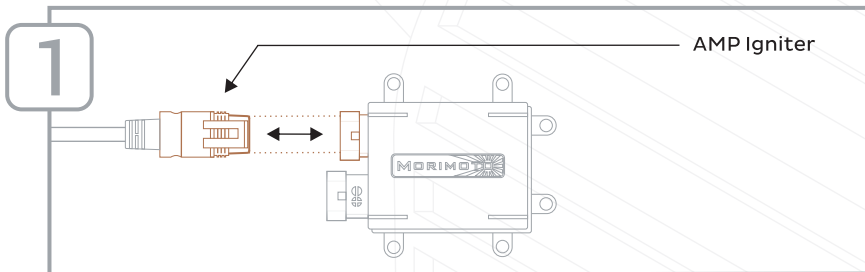

-END-